

Thump 12BST • Thump 15BST

1300W Advanced Powered Loudspeakers

OWNER'S MANUAL

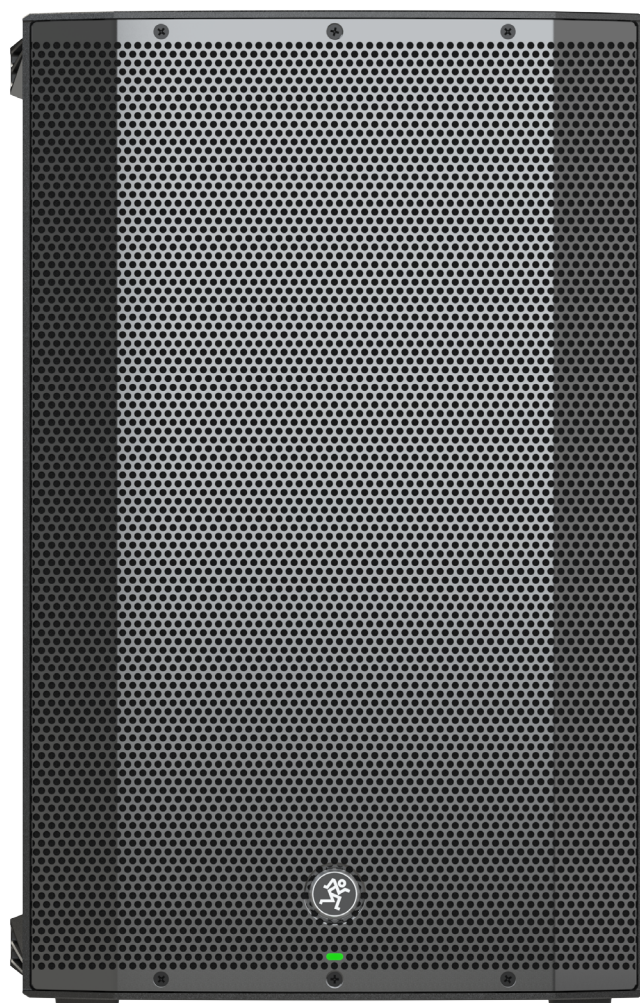
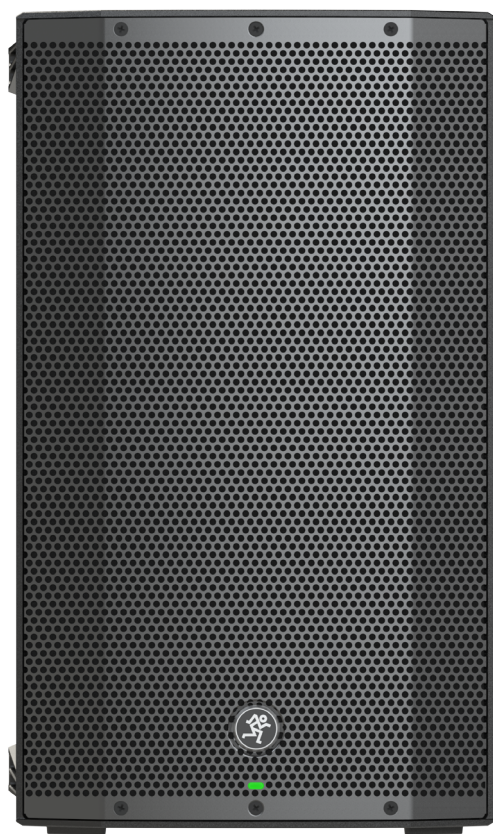

Important Safety Instructions

1. Read these instructions.
2. Keep these instructions.
3. Heed all warnings.
4. Follow all instructions.
5. Do not use this apparatus near water.
6. Clean only with a dry cloth.
7. Do not block any ventilation openings. Install in accordance with the manufacturer's instructions.
8. Do not install near any heat sources such as radiators, heat registers, stoves, or other apparatus (including amplifiers) that produce heat.
9. Do not defeat the safety purpose of the polarized or grounding-type plug. A polarized plug has two blades with one wider than the other. A grounding-type plug has two blades and a third grounding prong. The wide blade or the third prong are provided for your safety. If the provided plug does not fit into your outlet, consult an electrician for replacement of the obsolete outlet.
10. Protect the power cord from being walked on or pinched particularly at plugs, convenience receptacles, and the point where they exit from the apparatus.
11. Only use attachments/accessories specified by the manufacturer.
12. Use only with a cart, stand, tripod, bracket, or table specified by the manufacturer, or sold with the apparatus. When a cart is used, use caution when moving the cart/apparatus combination to avoid injury from tip-over.
13. Unplug this apparatus during lightning storms or when unused for long periods of time.
14. Refer all servicing to qualified service personnel. Servicing is required when the apparatus has been damaged in any way, such as power-supply cord or plug is damaged, liquid has been spilled or objects have fallen into the apparatus, the apparatus has been exposed to rain or moisture, does not operate normally, or has been dropped.
15. This apparatus shall not be exposed to dripping or splashing, and no object filled with liquids, such as vases or beer glasses, shall be placed on the apparatus.
16. Do not overload wall outlets and extension cords as this can result in a risk of fire or electric shock.
17. This apparatus has been designed with Class-I construction and must be connected to a mains socket outlet with a protective earthing connection (the third grounding prong).
18. This apparatus has been equipped with a rocker-style AC mains power switch. This switch is located on the rear panel and should remain readily accessible to the user.
19. The MAINS plug or an appliance coupler is used as the disconnect device, so the disconnect device shall remain readily operable.



20. NOTE: This equipment has been tested and found to comply with the limits for a Class B digital device, pursuant to part 15 of the FCC Rules. These limits are designed to provide reasonable protection against harmful interference in a residential installation. This equipment generates, uses, and can radiate radio frequency energy and, if not installed and used in accordance with the instructions, may cause harmful interference to radio communications. However, there is no guarantee that interference will not occur in a particular installation. If this equipment does cause harmful interference to radio or television reception, which can be determined by turning the equipment off and on, the user is encouraged to try to correct the interference by one or more of the following measures:

- Reorient or relocate the receiving antenna.
- Increase the separation between the equipment and the receiver.
- Connect the equipment into an outlet on a circuit different from that to which the receiver is connected.
- Consult the dealer or an experienced radio/TV technician for help.

CAUTION: Changes or modifications to this device not expressly approved by LOUD Technologies Inc. could void the user's authority to operate the equipment under FCC rules.

21. This device complies with FCC radiation exposure limits set forth for an uncontrolled environment. This device should be installed and operated with minimum distance 20cm between the radiator & your body.
22. This apparatus does not exceed the Class A/Class B (whichever is applicable) limits for radio noise emissions from digital apparatus as set out in the radio interference regulations of the Canadian Department of Communications.

ATTENTION — *Le présent appareil numérique n'émet pas de bruits radioélectriques dépassant les limites applicables aux appareils numériques de class A/de class B (selon le cas) prescrites dans le règlement sur le brouillage radioélectrique édicté par les ministere des communications du Canada.*

23. This device complies with Industry Canada's licence-exempt RSSs. Operation is subject to the following two conditions:

- (1) this device may not cause interference, and
- (2) this device must accept any interference, including interference that may cause undesired operation of the device.

Le présent appareil est conforme aux CNR d'Industrie Canada applicables aux appareils radio exempts de licence. L'exploitation est autorisée aux deux conditions suivantes:

- (1) l'appareil ne doit pas produire de brouillage, et
- (2) l'utilisateur de l'appareil doit accepter tout brouillage radioélectrique subi, même si le brouillage est susceptible d'en compromettre le fonctionnement.

24. Exposure to extremely high noise levels may cause permanent hearing loss. Individuals vary considerably in susceptibility to noise-induced hearing loss, but nearly everyone will lose some hearing if exposed to sufficiently intense noise for a period of time. The U.S. Government's Occupational Safety and Health Administration (OSHA) has specified the permissible noise level exposures shown in the following chart.

According to OSHA, any exposure in excess of these permissible limits could result in some hearing loss. To ensure against potentially dangerous exposure to high sound pressure levels, it is recommended that all persons exposed to equipment capable of producing high sound pressure levels use hearing protectors while the equipment is in operation. Ear plugs or protectors in the ear canals or over the ears must be worn when operating the equipment in order to prevent permanent hearing loss if exposure is in excess of the limits set forth here:

Duration, per day in hours	Sound Level dBA, Slow Response	Typical Example
8	90	Duo in small club
6	92	
4	95	Subway Train
3	97	
2	100	Very loud classical music
1.5	102	
1	105	John screaming at Troy about deadlines
0.5	110	
0.25 or less	115	Loudest parts at a rock concert

CAUTION

RISK OF ELECTRIC SHOCK! DO NOT OPEN!

CAUTION: TO REDUCE THE RISK OF ELECTRIC SHOCK DO NOT REMOVE COVER (OR BACK). NO USER-SERVICEABLE PARTS INSIDE. REFER SERVICING TO QUALIFIED PERSONNEL.

The lightning flash with arrowhead symbol within an equilateral triangle is intended to alert the user to the presence of uninsulated "dangerous voltage" within the product's enclosure, that may be of significant magnitude to constitute a risk of electric shock to persons.

The exclamation point within an equilateral triangle is intended to alert the user of the presence of important operating and maintaining (servicing) instructions in the literature accompanying the appliance.

WARNING — To reduce the risk of fire or electric shock, do not expose this apparatus to rain or moisture.

CAUTION — To prevent electric shock hazard, do not connect to mains power supply while grille is removed.

Laite on liitettävä suojakoskettimilla varustettuun pistorasiaan.

Apparatet må tilkoples jordet stikkontakt.

Apparaten skall anslutas till jordat uttag.

Correct disposal of this product: This symbol indicates that this product should not be disposed of with your household waste, according to the WEEE directive (2012/19/EU) and your national law. This product should be handed over to an authorized collection site for recycling waste electrical and electronic equipment (EEE). Improper handling of this type of waste could have a possible negative impact on the environment and human health due to potentially hazardous substances that are generally associated with EEE. At the same time, your cooperation in the correct disposal of this product will contribute to the effective usage of natural resources. For more information about where you can drop off your waste equipment for recycling, please contact your local city office, waste authority, or your household waste disposal service.

Contents

- Important Safety Instructions 2
- Contents / Features 3
- Introduction / Getting Started 4
- Hookup Diagrams..... 5

- Thump12BST / Thump15BST: Rear Panel Features .. 10
 - Thump Connect App 10
 - 1. Power Connection 10
 - 2. Power Switch 10
 - 3. XLR and 1/4" Combo Inputs..... 10
 - 4. Mix Out Output 11
 - 5. LCD Display 11
 - 6. Speaker Control Knob..... 11

- Speaker Control Functions..... 12
 - Mixer Screen 12
 - Level Setup 12
 - EQ Setup | Access Menu 13
 - Menu Screen 14
 - Mixer..... 14
 - Speaker Mode 14
 - Bluetooth 15
 - Configuration..... 17
 - Lock..... 18
 - LCD..... 18
 - BBQ 19

- Protection Circuitry 20
 - Limiting 20
 - Overexcursion Protection 20
 - Thermal Protection..... 20
- AC Power 20
- Care and Maintenance 20

- Placement..... 21
- Room Acoustics..... 22
- Rigging 23

- Appendix A: Service Information 24
- Appendix B: Technical Information 25
 - Thump12BST/Thump15BST Dimensions..... 26
 - Thump12BST/Thump15BST Frequency Response..... 27
 - Thump12BST/Thump15BST Block Diagram 28

- Limited Warranty 29

Features

- Power
 - 1300 Watts of high quality, dynamic peak power amplification
 - Switch-mode power supply with Power Factor Correction (PFC) for optimal performance in any AC line condition

- Drivers
 - 12" low frequency, high output driver for deep bass response [Thump12BST]
 - 15" low frequency, high output driver for deep bass response [Thump15BST]
 - 1.4" titanium dome compression driver for extended high frequency response

- Dynamic DSP bass boost delivers maximum Thump regardless of output

- Complete system protection and performance optimization
 - Independent HF & LF RMS limiters protect drivers from excess heat and damage
 - Independent HF & LF peak limiters eliminate clipping and distortion

- Simple, powerful full color rear panel user control screen and knob interface
 - Digitally controlled 3 channel mixer (Ch 1/2, BT, and Main)
 - High res metering
 - 3 band channel EQ with HPF (Ch 1/2)
 - Application specific speaker modes

- High quality wireless audio streaming and linking
 - Bluetooth Streaming from Android and iOS devices
 - Stereo linking of two Thump speakers for convenient wireless music playback
 - Device and link memory for quick set-up when using the same devices and speaker pair

- Thump Connect app for wireless control

- Durable, lightweight molded enclosure
 - Dual symmetrical monitor angles
 - Two full grip side handles plus top carry handle and bottom rear lift pocket
 - Rugged powder coated perforated steel grille with acoustically transparent cosmetic mesh
 - Vertical suspension via 3 M10 fly points
 - 29.3 lb / 13.3 kg
 - 35.1 lb / 15.9 kg



Watch our dang videos

Introduction

Delivering proven, chest-thumping low-end with Dynamic Bass Response™ technology in all-new, professional enclosures, the 1300W Thump™ loudspeakers take the series to a whole new level.

Get maximum versatility with built-in mixers and application-specific speaker modes. Experience the advanced DSP and wireless technology in Thump Boosted™ models with channel EQ, wireless streaming, user presets and more, all controlled with the Thump Connect™ app. And for maximum room-shaking low-end, pair your Thump speakers with the 1200W Thump18S Subwoofer.

Redesigned from the ground up, these are our most flexible and powerful Thump loudspeakers ever with the class-leading performance you need.

How to Use This Manual:

After this introduction, a getting started guide will help you get things set up fast. The hookup diagrams show some typical Thump12BST and Thump15BST setups, including some that involve the Thump18S subwoofer.



This icon marks information that is critically important or unique! For your own good, read and remember them...it is a good idea to pay special attention to these areas in the Owner's Manual marked with the "VERY IMPORTANT" hand icon.



There's an illustration of a microscope, so, of course, you're going to get more detailed information when you see this little guy. There are explanations of features and practical tips listed here.



It's a good idea to pay attention to text displayed next to a note icon, as this icon draws attention to certain features and functions relating to the usage of the ThumpBST Series.

Please write the serial numbers here for future reference (i.e., insurance claims, tech support, return authorization, make dad proud, etc.)

Purchased at:

Date of purchase:

Getting Started

The following steps will help you set up the loudspeakers quickly.

1. Make all initial connections with the power switches OFF on all equipment. Make sure the master volume, level and gain controls are all the way down.
2. If using a subwoofer, connect the outputs from the mixing console (or other signal source) to the inputs on the loudspeaker, then connect the mix out to the inputs of the subwoofers. Make sure the subwoofer's gain knob is set to "U" (unity gain).
3. If not using a subwoofer, connect the outputs from the mixing console (or other signal source) to the inputs on the rear panel of the loudspeakers.
4. Push the line cord securely into the subwoofer's/loudspeaker's IEC connectors and plug the other ends into grounded AC outlets. The subwoofer/loudspeaker may accept the appropriate voltage as indicated near the IEC connector.
5. Turn the mixer (or other signal source) on.
6. Turn the subwoofer on.
7. Turn the loudspeakers on.
8. Make sure the loudspeaker's channel levels are set to (or near) 0 dB.
9. Start the signal source and raise the mixer's main L/R fader up to a comfortably loud listening level.

Things to Remember:

- Never listen to loud music for prolonged periods. Please see the Safety Instructions on page 2 for information on hearing protection.
- As a general guide, the mixer (or other signal source) should be turned on first, subwoofers next, and Thump loudspeakers last. As such, the Thump loudspeakers should also be turned off first, followed by the subwoofers, then the mixer. This will reduce the possibility of any turn-on or turn-off thumps and other noises generated by any upstream equipment from coming out of the speakers.
- Save the shipping boxes and packing materials! You may need them someday. Besides, the cats will love playing in them and jumping out at you unexpectedly. Remember to pretend like you are surprised!
- Save your sales receipt in a safe place.

Hookup Diagrams

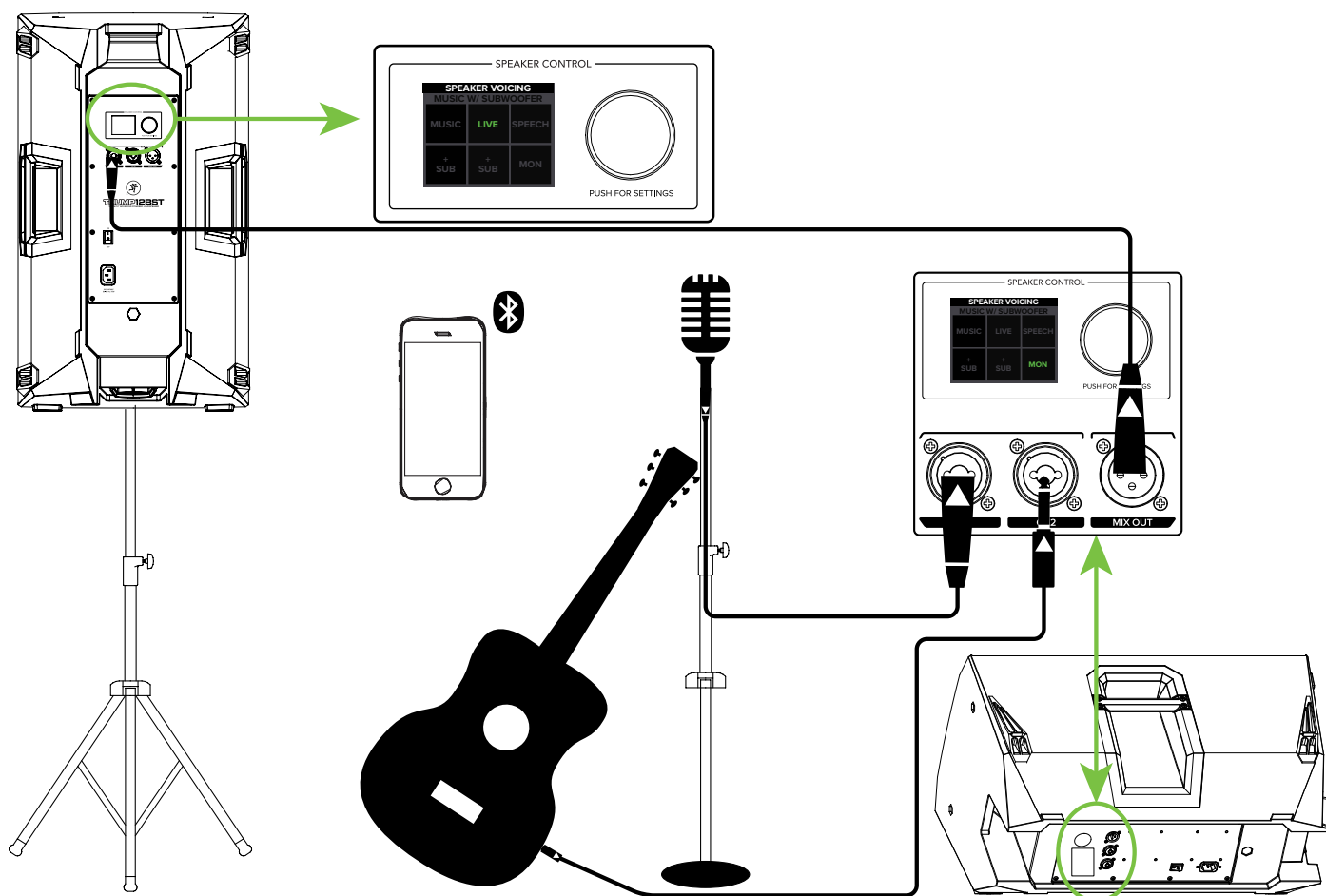

Thump loudspeakers are the perfect tool for singer-songwriters touring the local coffee shops. Bring your favorite axe and mic, Thump loudspeakers and cables and power cords.

In this example, a dynamic microphone is connected to the channel 1 input of a Thump12BST loudspeaker, used for monitoring purposes.

Now grab your axe and plug it directly into the channel 2 input. Or if you use effects, connect the guitar to the effects input and another cable from the effects output to the channel 2 input.

Another Thump12BST loudspeaker will be used for the main PA. Simply connect a cable from the Thump12BST monitor's MIX OUT jack to the Thump12BST PA's channel 1 input.

The last thing to connect is your device... via Bluetooth! With this, you can play backing tracks and/or programmed drum beats to accompany your brilliant performance to the adoring crowd! The bluetooth audio will stream to the monitor speaker and is linked to the main via the XLR connection. Do not wirelessly link the loudspeakers or you will get redundant audio from the bluetooth source!

For the output, you will want to set a speaker mode, described in detail on page 14. For this type of setup, Live works well for the main Thump12BST. However, don't count out the Music mode! Select the Monitor mode for the Thump12BST monitor.

Hookup Diagrams continued...

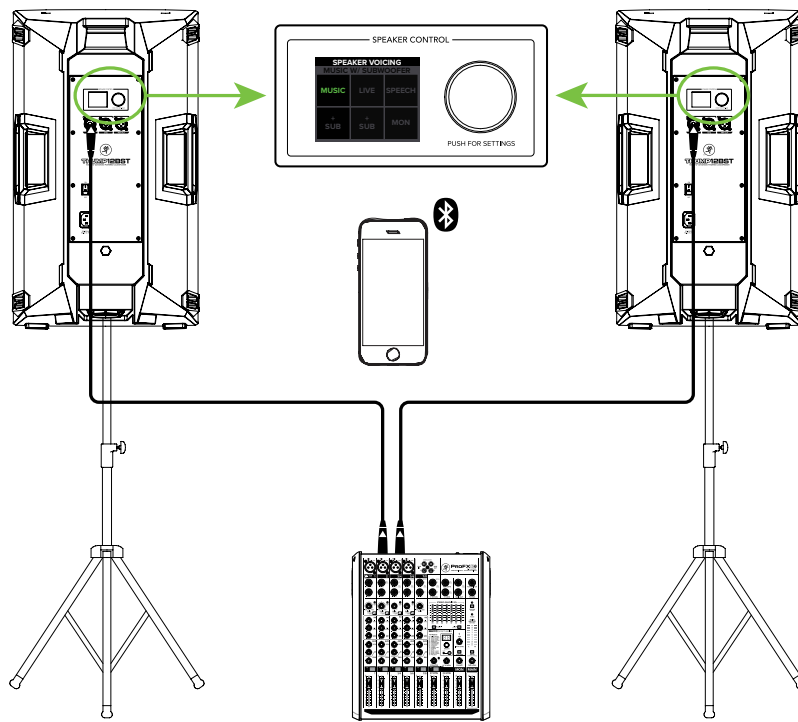

In this example, a ProFX8v2 mixer is connected directly to two Thump12BST loudspeakers. It is the perfect setup for a small club or... a fun karaoke house party! Simply connect the L/R outputs of the ProFX8v2 mixer to the CH1 input of each Thump12BST loudspeaker. For karaoke, you could play tunes through the device (connected via Bluetooth) with mics plugged directly into the inputs (or mixer first). Many options! Don't forget to wirelessly link the speakers for stereo audio playback from the device and set the Speaker Mode on both loudspeakers to Music!

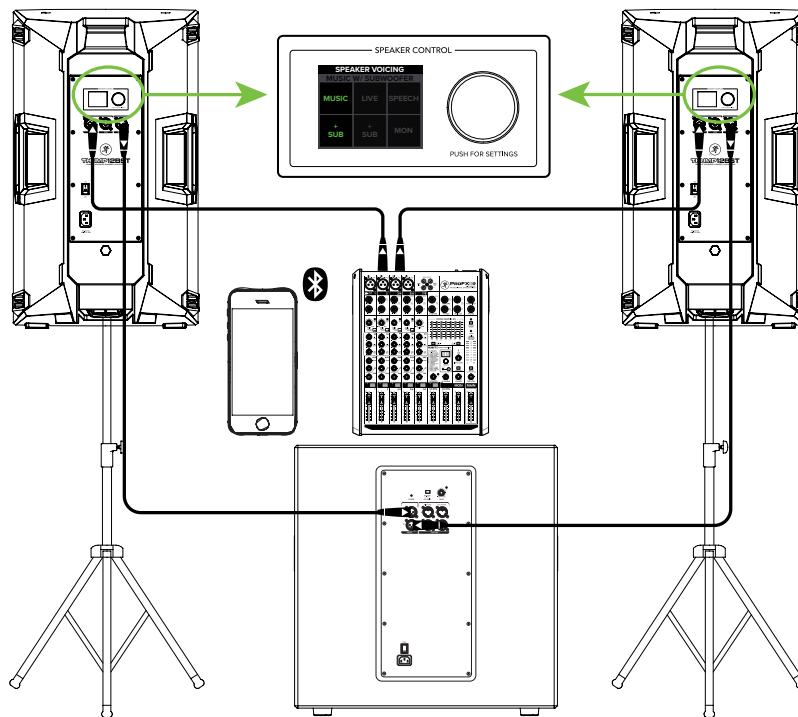

If you desire a little more boom, add a Thump18S subwoofer to the mix. Here, the L/R outputs of a ProFX8v2 mixer are connected directly to the CH1 inputs of each Thump12BST loudspeaker. Then the Mix Out of each loudspeaker is connected to the channel A and B inputs of a single Thump18S subwoofer. Don't forget to set the Speaker Modes to Music + Sub.

Small Club System

Hookup Diagrams continued...

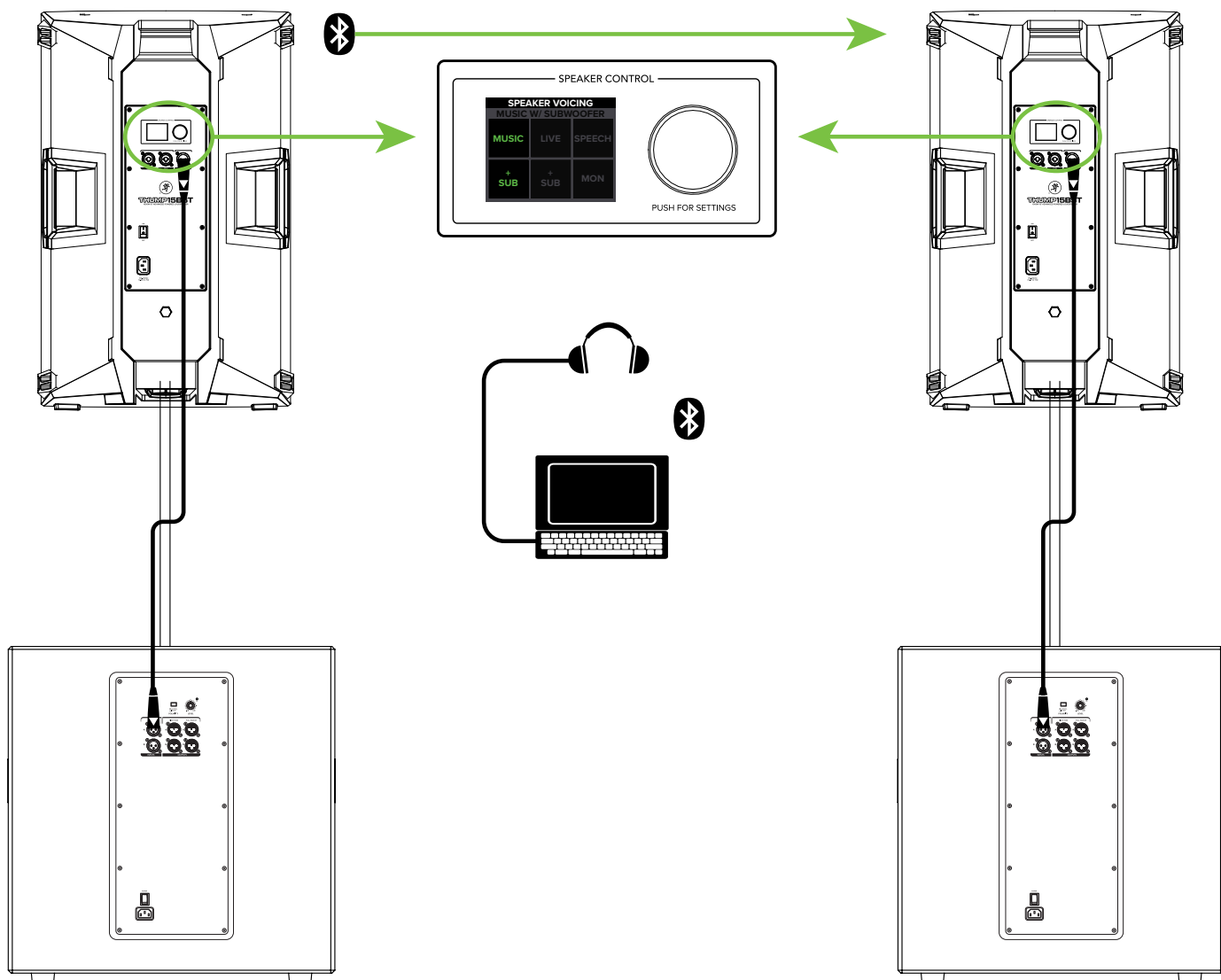

Perhaps you're a DJ playing bumpin' tunes in the middle of the night to a crowd that's groovin' and dancin' to your fine selection.

In this example, a laptop is connected to the bluetooth channel of a Thump15BST loudspeaker which, in turn, is linked to another Thump15BST loudspeaker.

The Mix Out of each loudspeaker is connected to the channel A input of each Thump18S subwoofer and a set of headphones is connected to the phones jack of the laptop.

The Speaker Modes of both loudspeakers may be set to Music + Sub. Would you look at that! Minimal cable spaghetti and up to 300 feet of bluetooth connectivity. A winning combination!

Hookup Diagrams continued...

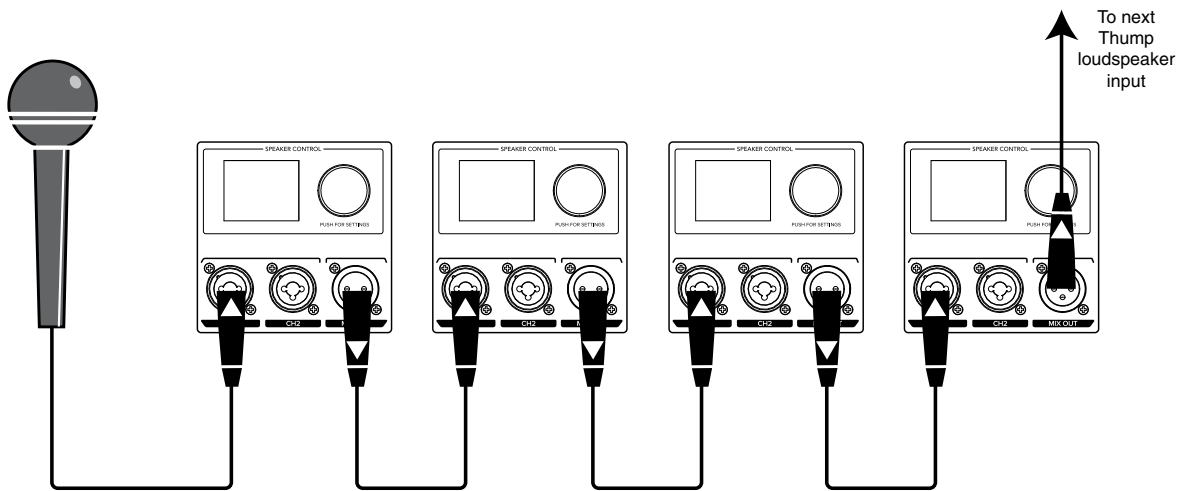
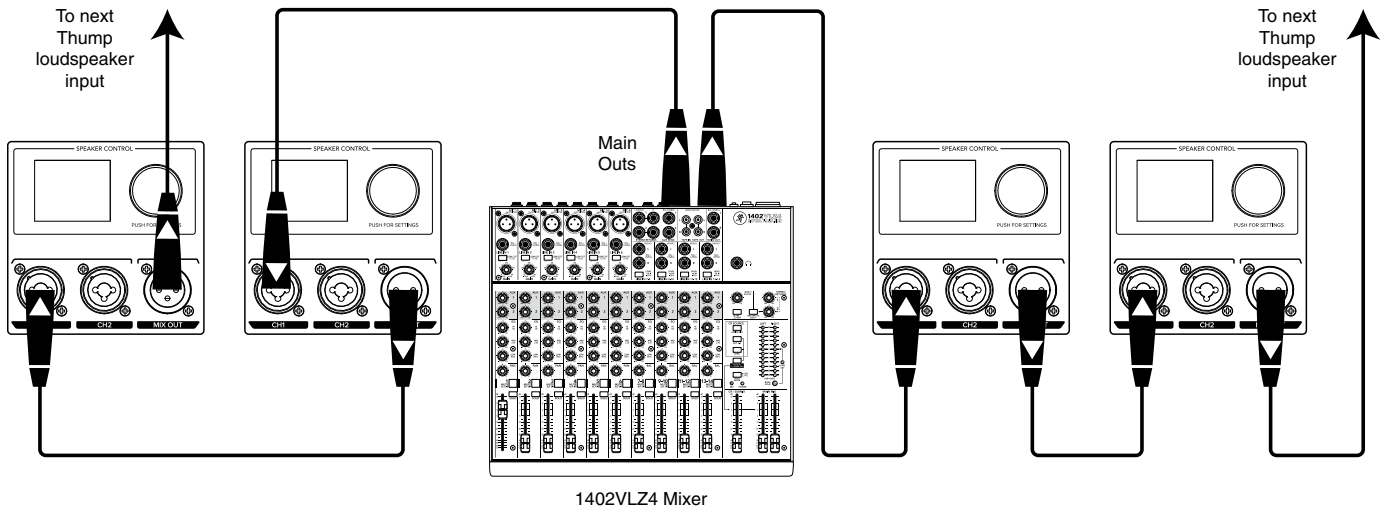

Thump loudspeakers may be daisy-chained via the male XLR connector labeled "MIX OUT". Simply plug the signal source (i.e., mixer output or microphone) into the input jack(s), and patch that loudspeaker's mix out jack to the next loudspeaker's input jack, and so on, daisy-chaining multiple Thump loudspeakers. See above for visual representations of daisy-chaining.

Daisy-Chaining Multiple Thump Loudspeakers

Hookup Diagrams continued...

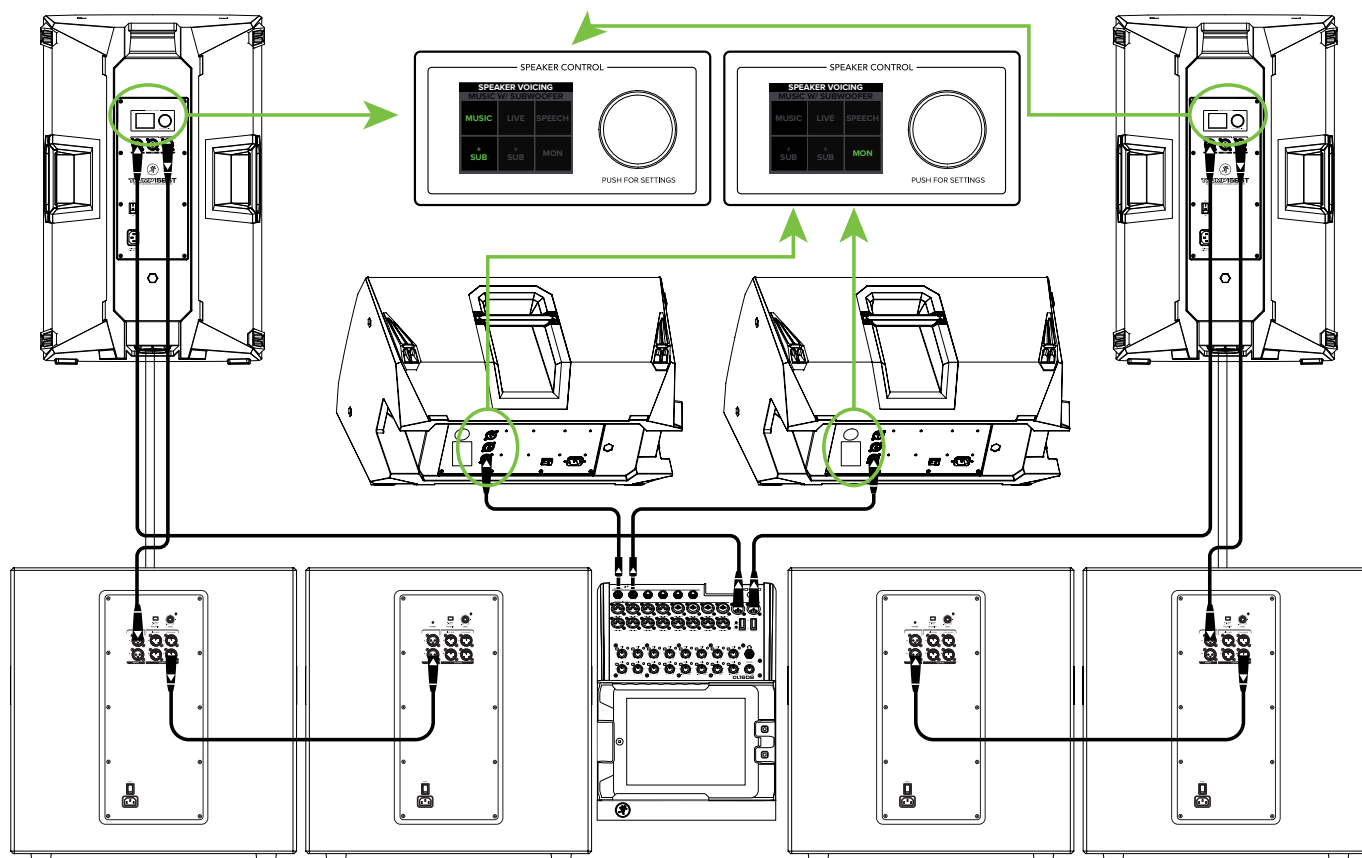

Here's how to set up a large club system. In this example, the L/R outputs of a DL1608 mixer are connected directly to the CH1 inputs of a pair of Thump15BST loudspeakers. The Speaker Modes of these PA loudspeakers may be set to Music + Sub.

The Mix Out of each loudspeaker is then connected to the channel A input of a pair of Thump18S subwoofers. From here, the channel A full range outputs of the two outer Thump18S subwoofers are connected directly to the channel A inputs of another set of Thump18S subwoofers. Talk about beefy low end!

The aux 1 and aux 2 sends from the mixer are connected directly to the CH1 inputs of a pair of Thump12BST loudspeakers to be used as monitors for the band. The Speaker Modes of the monitor loudspeakers may be set to Monitor.

There is no device shown in this hookup diagram, but it is entirely possible to connect one... after all, there is still a Bluetooth channel! It would be good for playback music during band breaks and set changeovers. The possibilities are endless!

Large Club System

Thump12BST / Thump15BST Loudspeakers: Rear Panel Features

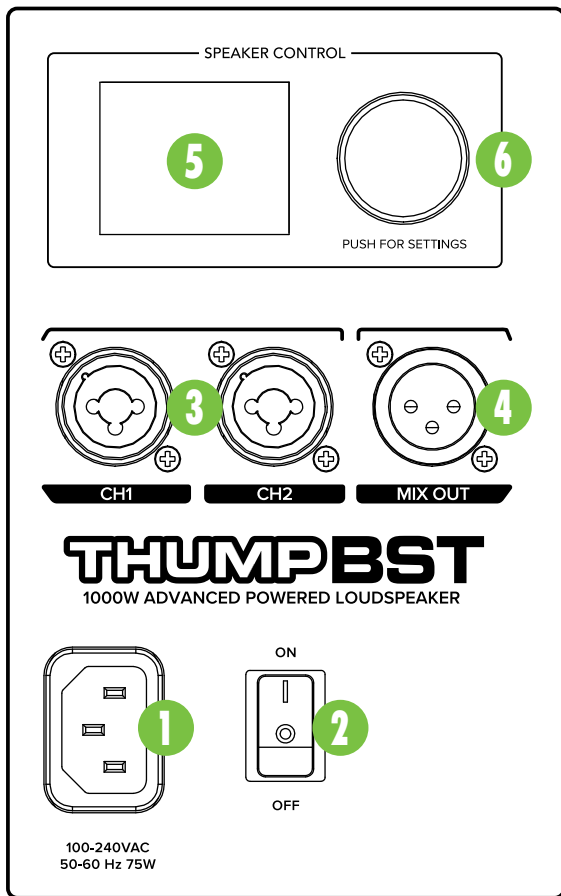

Thump Connect App

ThumpBST loudspeakers are designed to be used in conjunction with the Thump Connect App. With it, all of the hardware features listed here – and more! – may be controlled remotely via Bluetooth connection. The only thing the Thump Connect App can't do is turn the unit on and off.

More information about the Thump Connect App may be found by visiting the Thump Connect App Reference Guide.

1. Power Connection

This is a standard 3-prong IEC power connector. Connect the detachable power cord (included in the packaging with the loudspeaker) to the power receptacle, and plug the other end of the power cord into an AC outlet.



Make sure that the AC power is matched to the AC power indicated on the rear panel (below the IEC receptacle).



Disconnecting the plug's ground pin is dangerous. Don't do it!

2. Power Switch

Press the top of this rocker switch inwards to turn on the loudspeaker. Press the bottom of this rocker switch inwards to turn off the loudspeaker.



As a general guide, the mixer (or other signal source) should be turned on first, subwoofers next, and loudspeakers last. As such, the loudspeakers should also be turned off first, followed by the subwoofers, then the mixer. This will reduce the possibility of any turn-on or turn-off thumps and other noises generated by any upstream equipment from coming out of the speakers.

3. XLR and 1/4" Combo Inputs

Both input channels may accept a balanced mic signal using an XLR connector. They are wired as follows, according to standards specified by the AES (Audio Engineering Society).

XLR Balanced Wiring:

- Pin 1 = Shield (ground)
- Pin 2 = Positive (+ or hot)
- Pin 3 = Negative (- or cold)

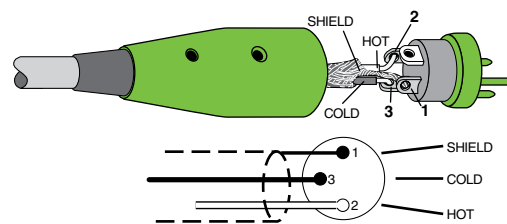

In addition to accepting a balanced mic signal using an XLR connector, these input channels may also accept 1/4" line-level signals driven by balanced or unbalanced sources.

Additionally, both input channels may accept Hi-Z sources (such as guitars) via the 1/4" input without the need for a separate DI box.

To connect balanced lines to these inputs, use a 1/4" Tip-Ring-Sleeve (TRS) plug. "TRS" stands for Tip-Ring-Sleeve, the three connection points available on a stereo 1/4" or balanced phone jack or plug. TRS jacks and plugs are used for balanced signals and are wired as follows:

1/4" TRS Balanced Mono Wiring:

- Sleeve = Shield
- Tip = Hot (+)
- Ring = Cold (-)

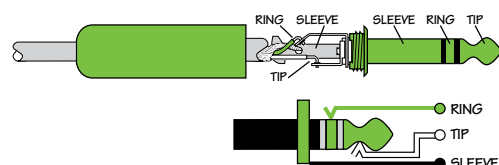

Thump12BST / Thump15BST Loudspeakers: Rear Panel Features continued...

To connect unbalanced lines to these inputs, use a 1/4" mono (TS) phone plug, wired as follows:

1/4" TS Unbalanced Mono Wiring:

Sleeve = Shield

Tip = Hot (+)

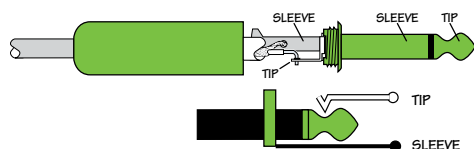

NEVER connect the output of an amplifier directly to a Thump's input jack. This could damage the input circuitry!

4. Mix Out

This is a male XLR-type connector that produces exactly the same signal that is connected to the input jacks. Use it to daisy-chain several Thump loudspeakers together off the same signal source(s).

They are wired as follows, according to standards specified by the AES (Audio Engineering Society):

Balanced XLR Output Connector

Pin 1 – Shield (ground)

Pin 2 – Positive (+ or hot)

Pin 3 – Negative (- or cold)

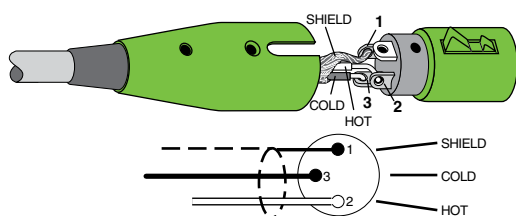

Balanced XLR Output Connector

See page 8 to learn more about daisy-chaining Thump loudspeakers.

5. LCD Display

This modern, high-resolution, all-color TFT LCD Display is one of the most vital features of the ThumpBST loudspeaker. It displays loudspeaker information including (but not limited to) levels, EQ, selected voicing, pairing the speakers and a bluetooth device, settings, lock / unlock status and other parameters. This is simply for for control and monitoring locally at the loudspeaker.



The brightness is controllable, but an overall screen brightness is required for certain aspects of the set-up options.

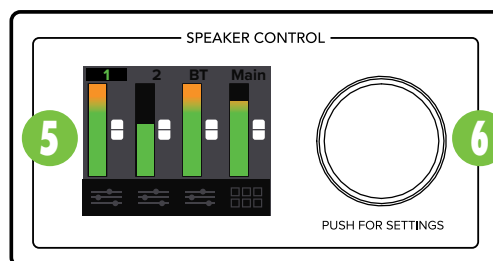

6. Speaker Control Knob

This push-button rotary encoder allows you to access functions such as channel and master level control and metering, application specific voicings & EQ, wireless configuration, setup functions, product information and much more! Details forthcoming...



The Bluetooth connection may disconnect when affected by electrostatic discharge (ESD) or electrical fast transients (EFT). If this occurs, manually reconnect the Bluetooth connection.

Speaker Control Functions

The following list provides the high level navigation items, in order, on the user interface and their subsequent user controlled parameters.

There are two screens to choose from as the default with each containing an array of sub-menus:

Mixer – I/O metering, level control, channel selection and control and more.

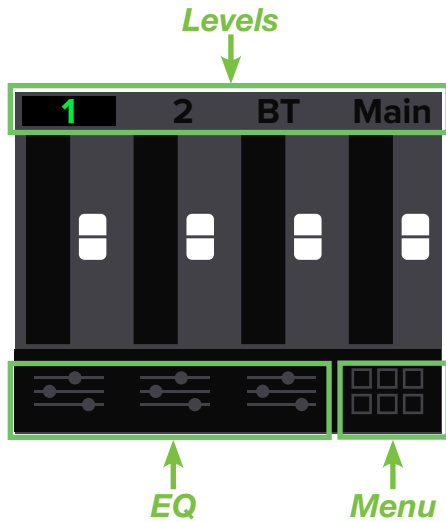

Menu – Provides icon selectors for all user-controllable functions.

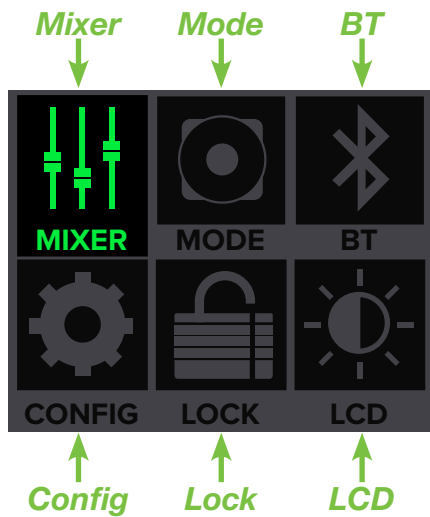

We will go through each, how to get there and how to change settings.

After a selection is made, the LCD screen will revert to your choice – either the Mixer or Menu screen – after 30 seconds of (speaker control) inactivity. You yourself may continue to be as active (or inactive) as you want.

Rotate the speaker control knob to navigate between the selections and push the button to open and edit the parameters.

Mixer Screen

As seen in the first screen shot to the left, the mixer screen is a representation of a mixer... a mixer on a loudspeaker? What?! Yup!

Level Setup

Rotate the speaker control knob to scroll between the selections. The current selection will illuminate in a can't-miss DayGlo green. In this example, channel 1 is selected. Once the parameter you want to change is illuminated, press the knob to enter edit mode.

The top row selections change the levels of input channels 1, 2 and BT and the Main output. Notice in the screenshots below how each parameter illuminates as the speaker control knob is rotated from channel 1 to 2, Bluetooth (BT) and the Main output last.

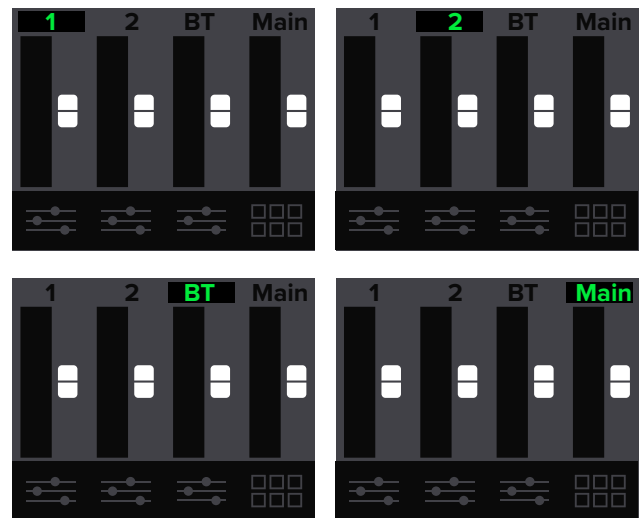

In order to change the level, push the speaker control knob when the desired channel is illuminated. In the same example, notice how the channel 2 fader has been moved to the -5 dB mark. Once the level you desire has been dialed in, press the speaker control knob again to return to the mixer screen.

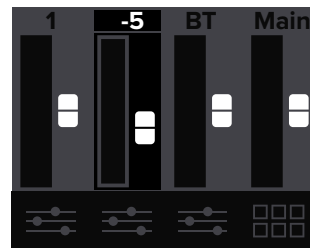

The level control ranges are as follows:

- Channels 1 and 2: -30 dB to +40 dB
- Bluetooth: -20 dB to 0 dB
- Main Output: -60 dB to +10 dB

NOTE All four may also be muted (via the Thump Connect app). Red fader caps indicate a muted channel, while white fader caps indicate unmuted channels.

A muted channel will unmute once a level is changed via the speaker control knob (or Thump Connect).

EQ Setup | Access Menu

Now, the bottom row also houses input channels 1, 2 and BT. But instead of raising or lowering levels, this is where to adjust each channels' EQ. Additionally, this is where to access the Menu screen.



In order to change a channel's EQ, push the speaker control knob when the desired channel's EQ icon is illuminated.

Next, push the speaker control knob again once the EQ you want to change is illuminated. See below.



The EQ ranges are as follows:

- High: ± 12 dB
@ 6 kHz [Channels 1 and 2]
@ 12 kHz [Bluetooth]
- Mid: ± 12 dB @ 2.5 kHz
- Low: ± 12 dB @ 80 Hz
- HPF: 20 Hz – 400 Hz at 12 dB per octave
[Channels 1 and 2 only]

As seen below, we changed the channel 1 high, mid and low EQ to +5 and the HPF setting to 110 Hz. Press the speaker control knob to return to the previous screen once the EQ settings you desire have been dialed in.



In addition to the four EQ choices shown above, there's a fifth and final selection: the left-facing arrow. Illuminating and selecting this simply returns you to the main mixer screen.



Other than the aforementioned EQ settings screen, this is also where to access the menu screen. From the mixer screen, simply rotate the speaker control knob right until the bottom right icon is illuminated (A). Then push the knob to enter the menu screen (B).

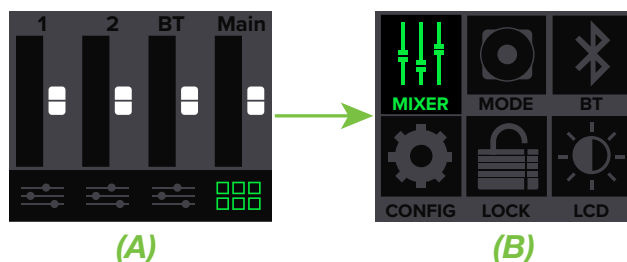

Let's take a look and see what the menu screen does. The first step is to flip the page!

Menu Screen

The menu screen displays six icons. Like the mixer screen, just rotate the speaker control knob until the icon of the parameter you want to change is illuminated. Then push the knob to enter that icon's screen.

The six icon selectors are as follows:

- Mixer
- Speaker Mode
- Bluetooth
- Configuration
- Lock
- LCD

We'll go through each one, starting with mixer at the top left.

Mixer

This is the easiest to describe since we just went through the mixer screen on the last two pages! To recap, though, the mixer screen is where to set levels and channel EQ.



Speaker Mode

Speaker mode allows you to change the loudspeaker's speaker mode to tailor it to best suit your particular application.

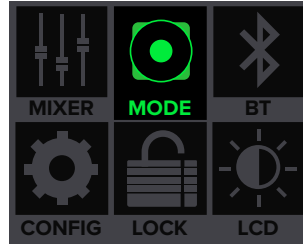

The six speaker modes are as follows:

- Music – This mode is full range, but focuses on increased bass and brilliant high frequencies. This is the place to start for most DJ / music playback applications.
- Live – This mode features a low frequency roll-off to get rid of unwanted thumps and adds boost and sparkle to mid-range and high frequencies. This plug-and-play mode is perfect for singer-songwriters.
- Speech – This mode features a significant low frequency roll-off to get rid of unwanted thumps. It also adds boost and sparkle to mid-range and high frequencies, critical for speech applications.

This plug-and-play mode is perfect for larger venue applications where speech is the primary audio source in need of clear and precise intelligibility.

- Music + Sub – This mode rolls off the low end of the ThumpBST loudspeaker to match properly with the Thump18S subwoofer.

SPEAKER VOICING		
MUSIC W/ SUBWOOFER		
MUSIC	LIVE	SPEECH
+ SUB	+ SUB	MON

- Live + Sub – This mode rolls off the low end of the ThumpBST loudspeaker to match properly with the Thump18S subwoofer.
- Monitor – This mode features a low frequency roll-off and a reduction around 2 kHz to ensure maximum gain before feedback in monitor applications.

As you had done previously, just rotate the speaker control knob until the speaker mode you desire is illuminated, then push to select it. As seen above, we selected Music + Sub.

Refer to the Frequency Response graphs on page 27 for further information.

Bluetooth

This is where to set up and view wireless connectivity options for the devices and speakers.

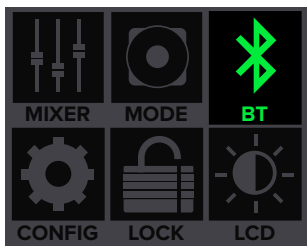

Below is a list of the parameters that may be edited:

Device – The device may either be paired or not paired.

To pair:

(1) Make sure “connect” is illuminated and push the speaker control knob.

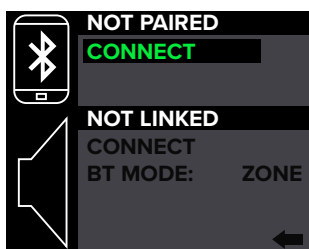

(2) The text “not paired” will change to “discoverable...” and “connect” will change to “cancel”. From here, you can either (A) turn the device and device’s bluetooth on to pair, or (B) push the speaker control knob to cancel the action.

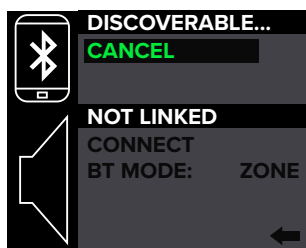

(3) The text “discoverable...” will change to “paired” and “cancel” will change to “disconnect”. From here, you can either (A) use the device and Thump Connect app to control the loudspeakers, or (B) push the speaker control knob to disconnect.

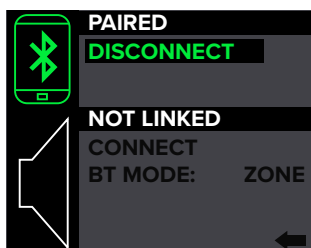

Notice how the icon of the device also illuminates when paired.

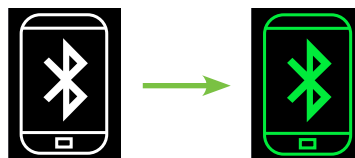

The Bluetooth connection may disconnect when affected by electrostatic discharge (ESD) or electrical fast transients (EFT).

If this occurs, manually reconnect the Bluetooth connection.

ThumpBST Loudspeaker – The loudspeaker may either be linked or not linked. Additionally, this is where to select the bluetooth mode [zone or stereo]. Lastly, if the bluetooth mode is stereo, you may select which loudspeaker is located on the left and which is on the right.

To link:

The steps to link speakers is quite similar to that of pairing a device. (1) Make sure “connect” is illuminated and push the speaker control knob.

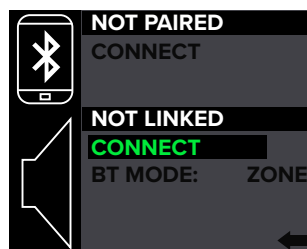

(2) The text “not linked” will change to “searching...” and “connect” will change to “cancel”. From here, you can either (A) turn the other ThumpBST on and follow these same steps to link, or (B) push the speaker control knob to cancel the action.

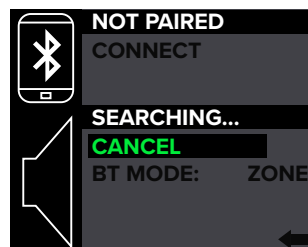

(3) The text “searching...” will change to “primary” on one loudspeaker and “secondary” on the other. Also, “cancel” will change to “disconnect”. From here, you can either (A) select a Bluetooth mode (see below), or (B) push the speaker control knob to disconnect.

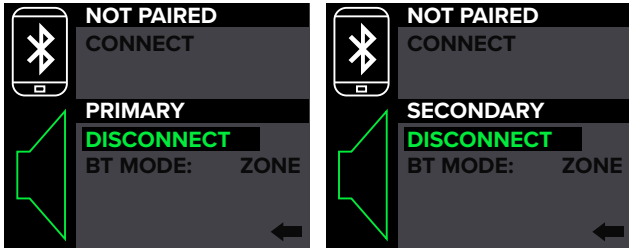

Notice how the icon of the loudspeaker also illuminates when linked.

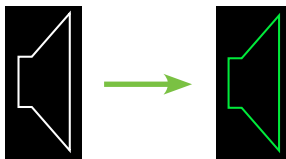

BT Mode – This is where to select the bluetooth mode [zone or stereo]. Rotate the speaker control knob until BT mode is illuminated then push it to enter and edit the BT mode.

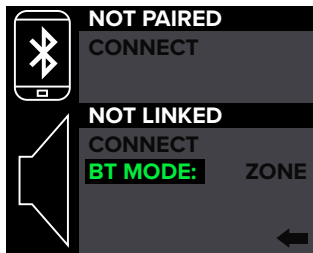

From here, rotate the speaker control knob until the bluetooth mode you prefer is illuminated: zone or stereo. Then push to select.

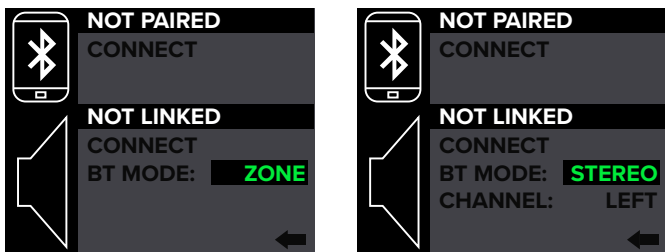

Zone

Stereo

So what’s the difference? Let’s take a look!

STEREO: The stereo setting is your default two loudspeaker setup, ideal for applications such as a party, DJ, etc., where a device is paired and streaming music in stereo. Here the main level controls both speakers.

The following channels are available when the Thump BSTs are linked in stereo:

- Ch. 1 Primary or Secondary
- Ch. 2 Primary or Secondary
- Bluetooth
- Stereo Main

If the bluetooth mode is set to stereo, you may select which loudspeaker is located on the left and which is on the right. Simply rotate the speaker control knob so that channel is illuminated, then push the button to enter and edit.

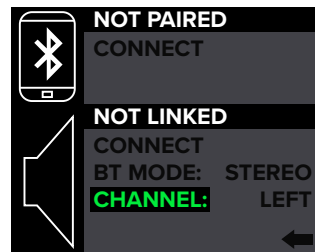

Rotate to illuminate your choice – left or right – then push the button to select.

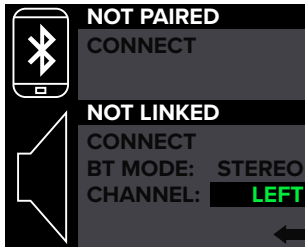

Left

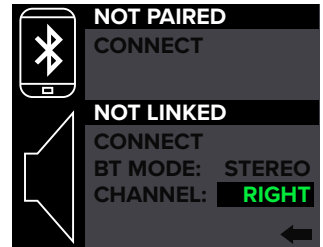

Right

ZONE: The zone mode setting is your optional loudspeaker setup, ideal for when the speakers are placed in different locations and allows for separate main level controls.

ThumpBST loudspeakers in zone mode setting will receive a mono-summed signal.

The following channels are available when the Thump BSTs are linked in zone mode:

- Ch. 1 Primary or Secondary
- Ch. 2 Primary or Secondary
- Bluetooth
- Primary or Secondary Main

As before, illuminating and selecting the left-facing arrow returns you to the previous screen.

Configuration

This is where to configure each speaker's LED status, auto connect / link bluetooth and more.

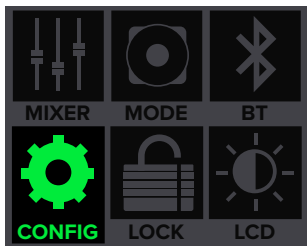

This is similar to what you will see after first entering the configuration screen.

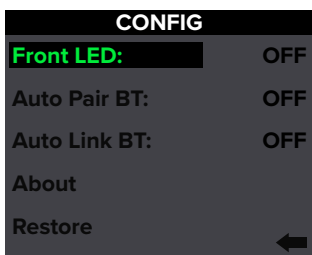

To change a setting, you will just need to rotate the speaker control knob until the configuration you desire to change is illuminated, then push to select it.

These are the choices from top to bottom:

Front LED – Decide if you want the front LED on or off. When illuminated, push the speaker control knob to select between on or off.

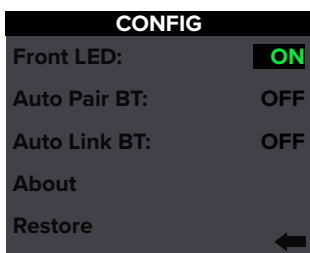

On

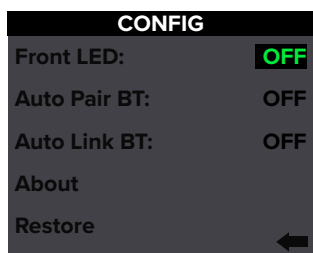

Off

Auto Pair BT – Allows a previously paired device to auto reconnect if both the device and speaker are powered on and in range. When illuminated, push the speaker control knob to select between on or off.

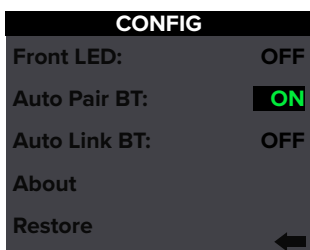

On

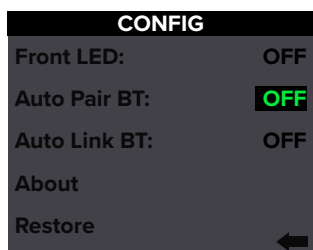

Off

Auto Link BT – Allows two previously paired speakers to automatically re-link if both are powered on and in range. When illuminated, push the speaker control knob to select between on or off.

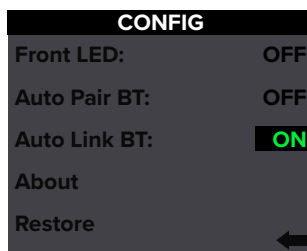

On

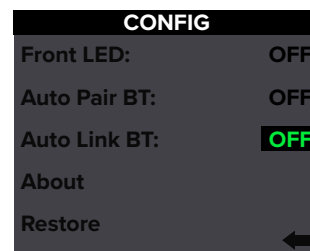

Off

About – Displays the current information about your loudspeaker. There is really only one reason to go here and that is if you've been directed so by Technical Support.

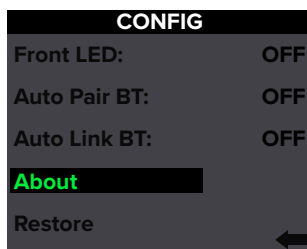

Restore – Restores all parameters back to their default. This is a permanent reset with no undo, so a confirmation dialog helps prevent accidents.



Yes



No

Illuminating and selecting the left-facing arrow returns you to the previous screen.

Lock

This is where to lock and unlock the interface with a secret 4-digit numeric password.

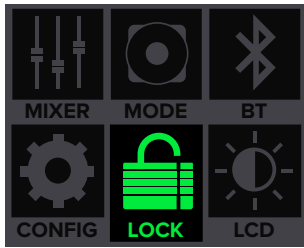

Locking – Push the speaker control knob to enter lock mode. From here, rotate the speaker control knob until the first number you desire is illuminated and press to select. Follow the same procedure for the next three numbers.

As seen below, we decided to go with 1-2-3-4 because that's (a "5" shy of) the same code that was used on *Spaceballs*. Notice how "lock" appears and is illuminated. Push the knob again to confirm the lock.

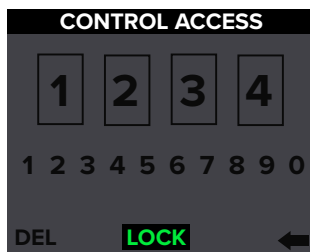

No further changes may be made until the control access is unlocked.

Unlocking – If you try to make any changes or select anything, you will be routed directly to the lock screen and the control access section. Here you will need to re-enter the 4-digit code and push the speaker control knob to unlock.

Secret Squirrel Unlock – If you – or worse, someone else! – set up a 4-digit lock code and you don't know the passcode, there is a quick fix. Simply press and hold down the speaker control knob down for a few seconds and it will automatically unlock.

Del, of course, deletes the previous selected number in case you made an oopsie. This is available whether locking or unlocking.

Illuminating and selecting the left-facing arrow returns you to the previous screen.

LCD

On the bottom-right is the LCD screen, where you may change the settings for the screen saver and (mixer and menu) home screen.

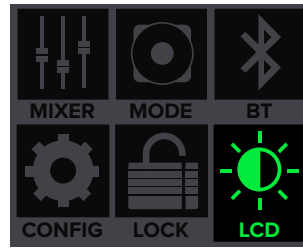

After pushing the speaker control knob on the LCD screen, you will see something that looks like this:

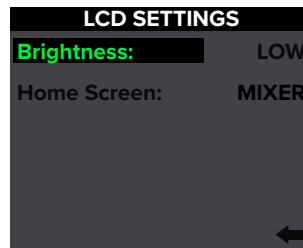

The parameter on top is LCD brightness. Push the speaker control knob again to edit the brightness. There are three choices: low, high and off.

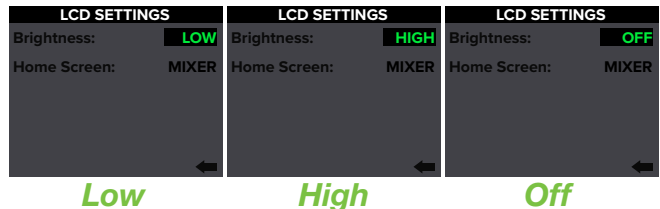

Low

High

Off



The brightness is controllable, but an overall screen brightness is required for certain aspects of the set-up options.

The next parameter that may be changed is the home screen. Here there are two choices: mixer and menu.

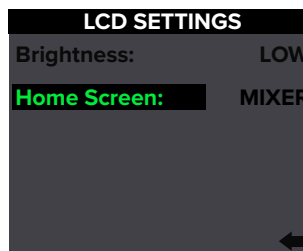

Both screens were shown and described several pages ago, but they're shown again below.

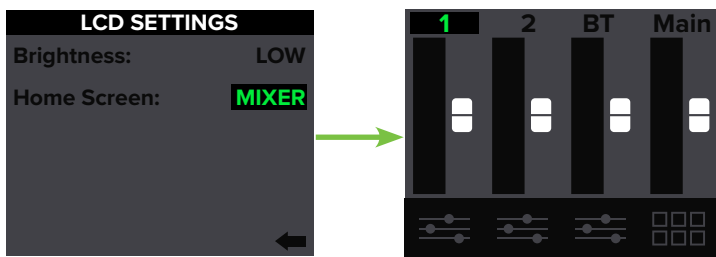

Mixer

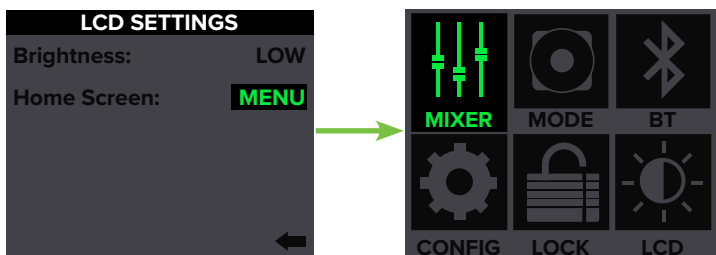

Menu

And, like before, illuminating and selecting the left-facing arrow returns you to the previous screen.

BBQ

Last, but not least... the BBQ screen! Who doesn't like to fire up the grill on a hot summer day, hang out with friends and drink ice cold beverages... perfection, right? Well, we agree, and decided to have a built-in BBQ right in the ThumpBST Series. Genius!

Simply rotate the speaker control knob until the grill is illuminated, then press to enter BBQ edit mode.

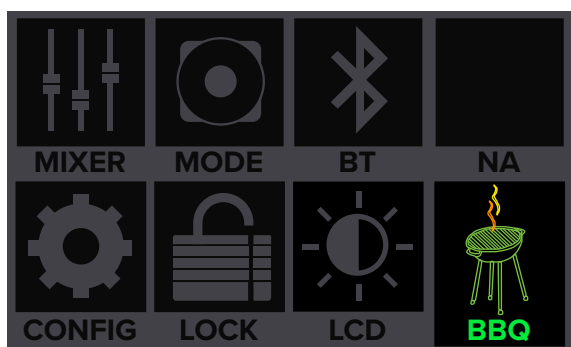

While a ThumpBST grille is one letter extra that of grill – and may *feasibly* be used as a grill – we don't recommend using it as such.

After pushing the speaker control knob on the BBQ screen, you will see something that looks like this:



The editable parameter on top is food. Push the speaker control knob again to edit the food. There are a variety of choices:

- Steak
- Burgers
- Hot Dogs
- Chicken / Wings
- Baby Back Ribs
- Fish
- Shish Kabobs
- Corn / Veggies

The next parameter that may be changed is the choice of frosty beverage. As with food, there are multiple options:

- Beer
- Wine
- Mixed Drinks
- Lemonade / Iced Tea
- Soda
- Water
- Coffee



The third – and final – parameter that may be changed are the games. Again, many choices:

- Cornhole
- Croquet
- Horseshoes
- Ring Toss
- Beer Pong
- Water Balloon Dodge Ball
- Wet T-shirt Contest
- Lawn Twister
- Sack Race



As always, illuminating and selecting the left-facing arrow returns you to the previous screen.

Protection Circuitry

Thump loudspeakers employ a built-in limiter for less distortion at peak levels. A dynamic bass response circuit provides optimal low frequency response regardless of overall output level. Additional protection includes automatic thermal shutdown should the amp overheat. However, with Class-D amp technology, which is highly-efficient, this should never be a problem.



The protection circuits are designed to protect the loudspeakers under reasonable and sensible conditions. Should you choose to ignore the warning signs [e.g. excessive distortion], you can still damage the speaker in the loudspeaker by overdriving it past the point of amplifier clipping. Such damage is beyond the scope of the warranty.

Limiting

The driver has its own compression circuit which helps protect it from damaging transient peaks. The compressor is designed to be transparent and is not noticeable under normal operating conditions.

Overexcursion Protection

A subsonic filter circuit just prior to the power amplifier prevents ultra-low frequencies from being amplified. Excessive low-frequency energy can damage the woofer by causing it to “bottom out,” also known as overexcursion, which is equivalent to a mechanical form of clipping.

Thermal Protection

All amplifiers produce heat. Thump loudspeakers are designed to be efficient both electrically and thermally. In the unlikely event of the amplifier overheating, a built-in thermal switch will activate, muting the signal.

When the amplifier has cooled down to a safe operating temperature, the thermal switch resets itself, and the Thump loudspeaker resumes normal operation.

If the thermal switch activates, try turning down the level control a notch or two on the mixing console (or via the Speaker Control knob) to avoid overheating the amplifier. Be aware that direct sunlight and/or hot stage lights may be the culprit of an amplifier overheating.

AC Power

Be sure the Thump loudspeaker is plugged into an outlet that is able to supply the correct voltage specified for your model. It will continue to operate at lower voltages, but will not reach full power. Be sure the electrical service can supply enough amperage for all the components connected to it.

We recommend that a stiff (robust) supply of AC power be used because the amplifiers place high current demands on the AC line. The more power that is available on the line, the louder the speakers will play and the more peak output power will be available for a cleaner, punchier bass. A suspected problem of “poor bass performance” is often caused by a weak AC supply to the amplifiers.



Never remove the ground pin on the power cord or any other component of the Thump loudspeaker. This is very dangerous.

Care and Maintenance

Your Thump loudspeakers will provide many years of reliable service if you follow these guidelines:

- Avoid exposing the loudspeakers to moisture. If they are set up outdoors, be sure they are under cover if rain is expected.
- Avoid exposure to extreme cold (below freezing temperatures). If you must operate the loudspeakers in a cold environment, warm up the voice coils slowly by sending a low-level signal through them for about 15 minutes prior to high-power operation.
- Use a dry cloth to clean the cabinets. Only do this when the power is turned off. Avoid getting moisture into any of the openings of the cabinet, particularly where the drivers are located.

Placement



WARNING: Installation should only be done by an experienced technician. Improper installation may result in damage to the equipment, injury or death. Make sure that the loudspeaker is installed in a stable and secure way in order to avoid any conditions that may be dangerous for persons or structures.

Thump loudspeakers are designed to sit on the floor or stage as the main PA or as monitors. They may also be pole-mounted via the built-in socket on the bottom of the cabinet. Be sure the pole is capable of supporting the weight of the loudspeaker. The SPM200 is a great option when using a subwoofer.

These loudspeakers may also be flown via their integrated fly points as detailed on page 23. Be sure to read the PA-A1 Eyebolt Installation Instructions, as well.



NEVER attempt to suspend a Thump loudspeaker by its handles.

Check to make sure that the support surface (e.g. floor, etc.) has the necessary mechanical characteristics to support the weight of the loudspeaker(s).

When pole-mounting loudspeakers, be sure that they are stabilized and secured from falling over or being accidentally pushed over. Failure to follow these precautions may result in damage to the equipment, personal injury, or death.

As with any powered components, protect them from moisture. Avoid installing the loudspeaker in places exposed to harsh weather conditions. If you are setting them up outdoors, make sure they are under cover if you expect rain.

Thump loudspeakers are **NOT** designed to array horizontally. If you feel you must put two speakers side-by-side, you should have a good understanding of the relationship between the splay angle (the angle between the facing sides of the cabinets) and frequency cancellation effects between cabinets.

When two cabinets are positioned side-by-side such that the rear-angled faces of the enclosures are parallel, the splay angle will be 90° . This matches the 90° horizontal coverage pattern of each individual loudspeaker; the interference between the two cabinets will be minimized, but the total coverage of 180° may be too wide for some applications. The mid and high frequencies may also be reduced for those in the center who are too close to the loudspeakers.

Reducing the splay angle will reduce the total horizontal coverage, but it also creates an area both speakers are covering. Instead of a nearfield hole, this will cause comb-filtering effects in the frequency response in the overlapping area. The smaller the splay angle, the more energy will be delivered on-axis, but the comb-filtering effects will get worse at the same time.

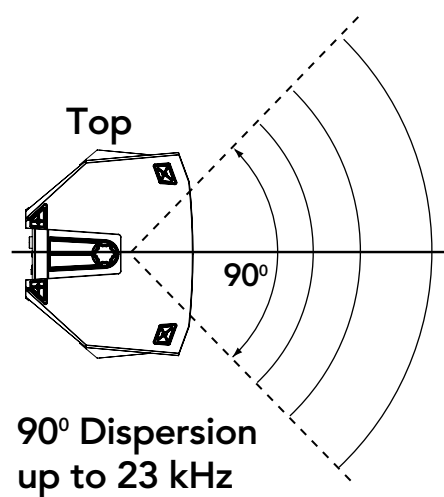

To reiterate, though, we strongly suggest **NOT** arraying these loudspeakers horizontally. Experimentation and experience will help you find the right balance for your application.

Room Acoustics

Thump loudspeakers are designed to sound fantastic in nearly every application.

But, room acoustics play a crucial role in the overall performance of a sound system. However, the wide high-frequency dispersion of the Thump loudspeakers helps to minimize the problems that typically arise.

Here are some additional placement tips to help overcome some typical room problems that might arise:

- Placing loudspeakers in the corners of a room increases the low frequency output and can cause the sound to be muddy and indistinct.
 - Placing loudspeakers against a wall increases the low frequency output, though not as much as corner placement. However, this is a good way to reinforce the low frequencies, if so desired.
 - Avoid placing the speakers directly on a hollow stage floor. A hollow stage can resonate at certain frequencies, causing peaks and dips in the frequency response of the room. It is better to place them on a sturdy stand designed to handle the weight of the loudspeaker.
 - Position the loudspeakers so the high-frequency drivers are two to four feet above ear level for the audience (making allowances for an audience that may be standing/dancing in the aisles). High frequencies are highly directional and tend to be absorbed much easier than lower frequencies. By providing direct line-of-sight from the loudspeakers to the audience, you increase the overall brightness and intelligibility of the sound system.
- Highly reverberant rooms, like many gymnasiums and auditoriums, are a nightmare for sound system intelligibility. Multiple reflections off the hard walls, ceiling, and floor play havoc with the sound. Depending on the situation, you may be able to take some steps to minimize the reflections, such as putting carpeting on the floors, closing draperies to cover large glass windows, or hanging tapestries or other materials on the walls to absorb some of the sound.

However, in most cases, these remedies are not possible or practical. So what do you do? Making the sound system louder generally doesn't work because the reflections become louder, too. The best approach is to provide as much direct sound coverage to the audience as possible. The farther away you are from the speaker, the more prominent will be the reflected sound.

Use more speakers strategically placed so they are closer to the back of the audience. If the distance between the front and back speakers is more than about 100 feet, you should use a delay processor to time-align the sound. (Since sound travels about 1 foot per millisecond, it takes about 1/10 of a second to travel 100 feet.)

Keep in mind that the speaker mode is a great way to compensate for some of these issues. See page 14 for more information.

Rigging



WARNING: Installation should only be done by an experienced technician. Improper installation may result in damage to the equipment, injury or death. Make sure that the loudspeaker is installed in a stable and secure way in order to avoid any conditions that may be dangerous for persons or structures.



WARNING: The cabinet is suitable for rigging via its fly points. NEVER attempt to suspend a Thump loudspeaker by its handle.

Rigging Design Practices

Rigging a loudspeaker requires determining:

1. The rigging methods and hardware that meet static, shock, dynamic, and any other load requirements for supporting the loudspeaker from structure.
2. The design factor and required WLL (Working Load Limit) for this support.

We strongly recommend the following rigging practices:

1. Documentation: Thoroughly document the design with detailed drawings and parts lists.
2. Analysis: Have a qualified professional, such as a licensed Professional Engineer, review and approve the design before its implementation.
3. Installation: Have a qualified professional rigger do the installation and inspection.
4. Safety: Use adequate safety precautions and back-up systems.

Rigging Hardware and Accessories

Rigging our loudspeakers will invariably require hardware not supplied by us. Various types of load-rated hardware are available from a variety of third-party sources. There are a number of such companies specializing in manufacturing hardware for designing and installing rigging systems. Each one of these tasks is a discipline in its own right. Because of the hazardous nature of rigging work and the potential liability, engage companies that specialize in these disciplines to do the work required.

We do offer certain accessory rigging items and some of them may be used with a variety of products. While these accessories are intended to facilitate installation, the wide variety of possible installation conditions and array configurations do not permit us to determine their suitability or load rating for any particular application.

We are not in the business of providing complete rigging systems, either as designers, manufacturers, or installers. It is the responsibility of the installer to provide a properly engineered, load-certified rigging system for supporting the loudspeaker from structure.



Thump loudspeakers may be individually flown using a PA-A1 Eyebolt Kit, part number 0031943.

Rigging Notes

The Thump loudspeaker's integral mounting points are designed to support only the weight of their own loudspeaker with suitable, external hardware. This means that each Thump loudspeaker must be supported independently of any other Thump loudspeaker and any other loads. All rigging points must be used to hang an Thump loudspeaker.

Thump12BST / Thump15BST Fly Points

MP = Mounting Point

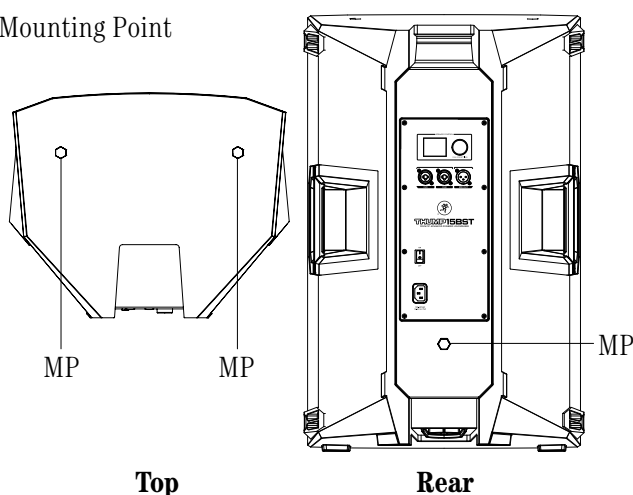

Appendix A: Service Information

If you think your Thump loudspeaker has a problem, please check out the following troubleshooting tips and do your best to confirm the problem. Visit the Support section of our website (www.mackie.com/support) where you will find lots of useful information such as FAQs and other documentation. You may find the answer to the problem without having to part with your loudspeaker.

Troubleshooting

No power

- Our favorite question: Is it plugged in? Make sure the AC outlet is live [check with a tester or lamp].
- Our next favorite question: Is the power switch on? If not, try turning it on.
- Make sure the line cord is securely seated in the line cord socket and plugged all the way into the AC outlet.
- Is the power LED on the front panel illuminated? If not, make sure the AC outlet is live. If so, refer to "No sound" below.
- The internal AC line fuse may be blown. This is not a user serviceable part. If you suspect the AC line fuse is blown, please see the "Repair" section next.

No sound

- Is the level knob for the input source turned all the way down? Verify that all the volume controls in the system are properly adjusted. Look at the level meter to ensure that the mixer is receiving a signal.
- Is the signal source working? Make sure the connecting cables are in good repair and securely connected at both ends. Make sure the output level control on the mixing console is turned up sufficiently to drive the inputs of the speaker.
- Make sure the mixer does not have a mute on or a processor loop engaged. If you find something like this, make sure the level is turned down before disengaging the offending switch.
- Has it shut down? Make sure there is at least six inches of free space behind each Thump loudspeaker.

Poor sound

- Is it loud and distorted? Make sure that you're not overdriving a stage in the signal chain. Verify that all level controls are set properly.
- Is the input connector plugged completely into the jack? Be sure all connections are secure.

Noise

- Make sure all connections to the active loudspeakers are good and sound.
- Make sure none of the signal cables are routed near AC cables, power transformers, or other EMI-inducing devices.
- Is there a light dimmer or other SCR-based device on the same AC circuit as the Thump loudspeaker? Use an AC line filter or plug the loudspeaker into a different AC circuit.

Hum

- Try disconnecting the cable connected to the input jack. If the noise disappears, it could be a "ground loop," rather than a problem with the Thump loudspeaker. Try some of the following troubleshooting ideas:
 - Use balanced connections throughout your system for the best noise rejection.
 - Whenever possible, plug all the audio equipment's line cords into outlets which share a common ground. The distance between the outlets and the common ground should be as short as possible.

Bluetooth Issues

- Please email or call Technical Support if you are having Bluetooth connection issues:
 - o mackie.com/support-contact
 - o 1-800-898-3211

Repair

For warranty service, refer to the warranty information on page 29.

Non-warranty service is available at a factory-authorized service center. To locate the nearest service center, visit www.mackie.com/support/service-locator. Service for Thump loudspeakers living outside the United States may be obtained through local dealers or distributors.

If you do not have access to our website, please call our Tech Support department at 1-800-898-3211 (normal business hours, Pacific Time), to explain the problem. They will tell you where the nearest factory-authorized service center is located in your area.

Appendix B: Technical Information

Thump12BST / Thump15BST Loudspeakers Specifications

Acoustic Performance

Frequency Range (-10 dB):	50 Hz – 23 kHz [Thump12BST] 32 Hz – 23 kHz [Thump15BST]
Frequency Range (-3 dB):	57 Hz – 20 kHz [Thump12BST] 39 Hz – 20 kHz [Thump15BST]
Horizontal Coverage Angle:	90°
Vertical Coverage Angle:	60°
Maximum SPL Peak:	126 dB [Thump12BST] 127 dB [Thump15BST]
Monitor Angle	45°

Transducers

Low Frequency:	12 in / 305 mm [Thump12BST] 15 in / 381 mm [Thump15BST] with ferrite
High Frequency:	1.4 in / 36 mm Titanium dome compression driver

Power Amplifiers

System Power Amplification	
Rated Power	1300 watts peak
Low Frequency Power Amplifier	
Rated Power:	1000 watts peak
Rated THD	< 1%
Cooling	Convection
Design:	Class D
High Frequency Power Amplifier	
Rated Power:	300 watts peak
Rated THD	< 1%
Cooling	Convection
Design:	Class AB

System Processing

Channel EQ	3-band, HPF
Main EQ	6 speaker modes
Loudspeaker Link	Stereo / Zone [BT Mode]
LCD Settings	Screen Saver / Home Screen

Equalization

Low	±12 dB @ 80 Hz
Mid	±12 dB @ 2.5 kHz
High	±12 dB @ 6 kHz [Ch. 1/2] ±12 dB @ 12 kHz [Bluetooth]
Increments	±1 dB
HPF	20 Hz – 400 Hz @12 dB / octave [Ch. 1/2 only]

Input/Output

Input Type:	2x Female XLR Balanced / 1/4" Unbalanced
Mic-Line Impedance:	8 kΩ balanced
1/4" TS, Wide-Z™ Impedance:	1 MΩ unbalanced
Mix Out:	Male XLR Balanced
Mix Out Impedance:	600 Ω balanced
Main Control:	Rotating knob

Electronic Crossover

Crossover Type:	24 dB/octave
Crossover Frequency:	2 kHz

Line Input Power

Detachable line cord	100 – 240 VAC, 50 – 60 Hz, 75W
AC Connector	3-pin IEC 250 VAC, 10 A male
Power Supply Type	Switchmode

Safety Features

Input Protection	Peak and RMS limiting, power supply and amplifier thermal protection
Display LEDs	Defeatable front power, Speaker Control
Status Info	Input and output levels, EQ speaker voicing

Bluetooth Information

Bluetooth Protocol	3.0
Bluetooth Function	Audio Streaming and User Interface Control
Bluetooth Class	Class 1

Construction Features

Basic Design:	Trapezoidal
Material:	Polypropylene
Finish:	Black, textured finish
Handles:	One on each side, one on top, one on bottom
Grille:	Perforated metal with weather-resistant coating
Display LEDs	
Front:	Power ON
Rear:	Speaker Control
Operating Temperature:	0 – 40 °C 32 – 104 °F

Thump Loudspeaker Specifications continued...

Physical Properties

Thump12BST:

Height:	24.2 in / 615 mm
Width:	14.1 in / 358 mm
Depth:	14.0 in / 356 mm
Weight:	29.3 lb / 13.3 kg

Thump15BST:

Height:	27.0 in / 686 mm
Width:	17.4 in / 442 mm
Depth:	14.0 in / 356 mm
Weight:	35.1 lb / 15.9 kg

Mounting Methods:

Floor mount, pole mount via the built-in socket on the bottom of the cabinet [Be sure the pole is capable of supporting the weight of the Thump loudspeaker] or fly via three integrated M10 mounting points (using M10 x 1.5 x 20 mm forged shoulder eyebolts).

See page 23 for more information.

Options

Thump12BST Speaker Bag	P/N 2047360-09
Thump12BST Rolling Speaker Bag	P/N 2047360-10
Thump15BST Speaker Bag	P/N 2047360-11
Thump15BST Rolling Speaker Bag	P/N 2047360-12
SPM200 Loudspeaker Pole Mount	P/N 2035170-01
PA-A1 Forged Shoulder Eyebolt Kit (3 x M10 x 1.5 x 20 mm)	P/N 0031943

Disclaimer

Since we are always striving to make our products better by incorporating new and improved materials, components, and manufacturing methods, we reserve the right to change these specifications at any time without notice.

The "Running Man" figure is a registered trademark of LOUD Technologies Inc.

All other brand names mentioned are trademarks or registered trademarks of their respective holders, and are hereby acknowledged.

©2017 LOUD Technologies Inc.
All Rights Reserved.

Thump12BST Loudspeaker Dimensions

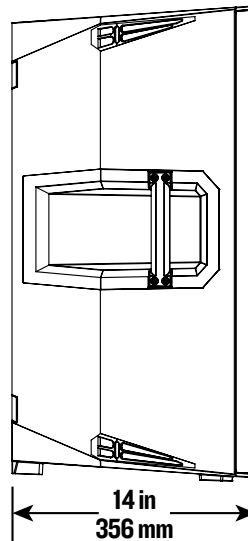
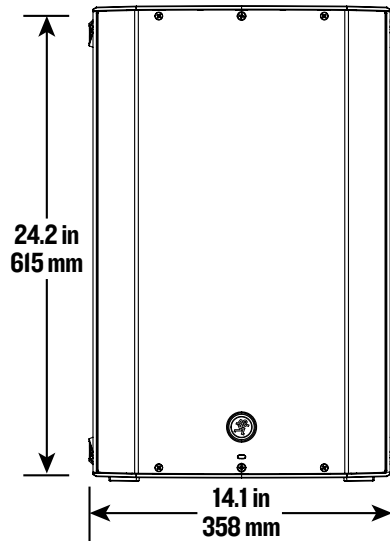

Thump15BST Loudspeaker Dimensions

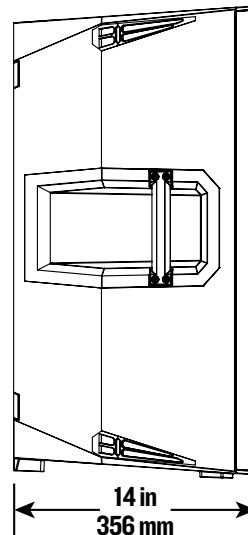
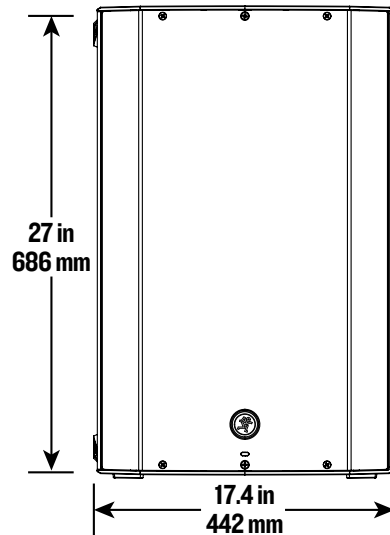

Thump12BST and Thump15BST Loudspeaker Frequency Response Legend

Music Speaker Mode – This mode is full range, but focuses on increased bass and brilliant high frequencies. This is the place to start for most DJ / music playback applications.

Live Speaker Mode – This mode features a low frequency roll-off to get rid of unwanted thumps and adds boost and sparkle to mid-range and high frequencies. This mode is perfect for plug-and-play singer-songwriters.

Monitor Speaker Mode – This mode features a low frequency roll-off and a reduction around 2 kHz to ensure maximum gain before feedback in monitor applications.

Music + Sub Speaker Mode – This mode rolls off the low end of the ThumpBST loudspeaker to match properly with the Thump18S subwoofer.

Live + Sub Speaker Mode – This mode rolls off the low end of the ThumpBST loudspeaker to match properly with the Thump18S subwoofer.

Speech Speaker Mode – This mode features a significant low frequency roll-off to get rid of unwanted thumps. It also adds boost and sparkle to mid-range and high frequencies, critical for speech applications. This plug-and-play mode is perfect for larger venue applications where speech is the primary audio source in need of clear and precise intelligibility.

Thump12BST Loudspeaker Frequency Response

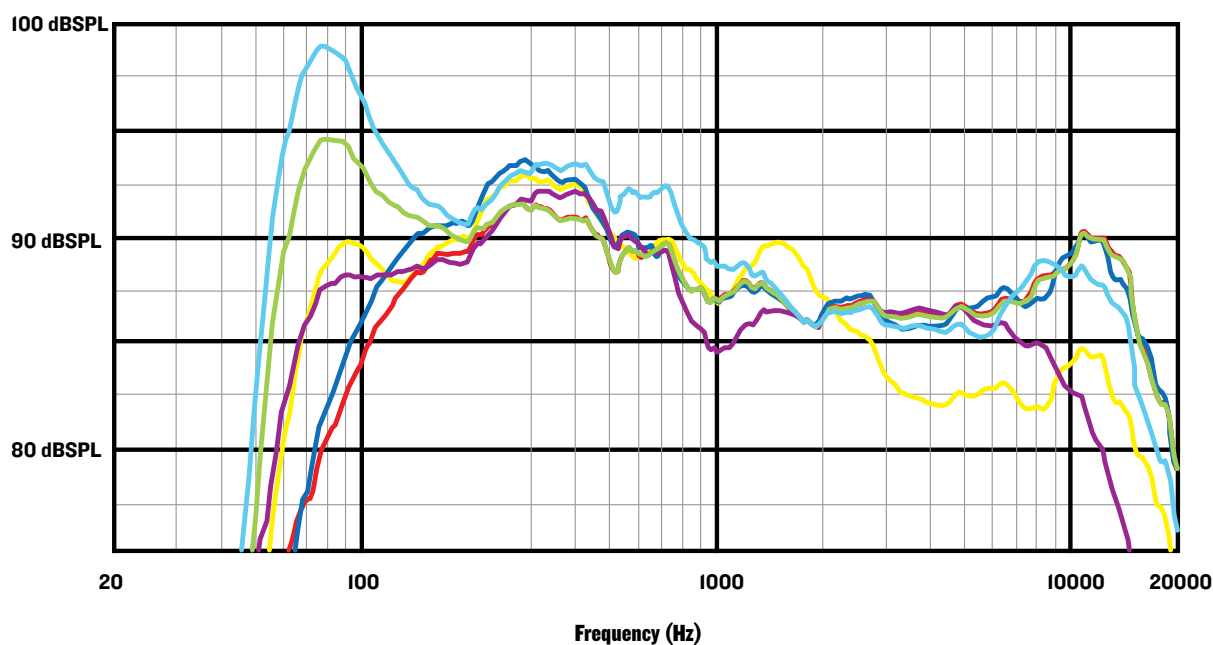

Thump15BST Loudspeaker Frequency Response

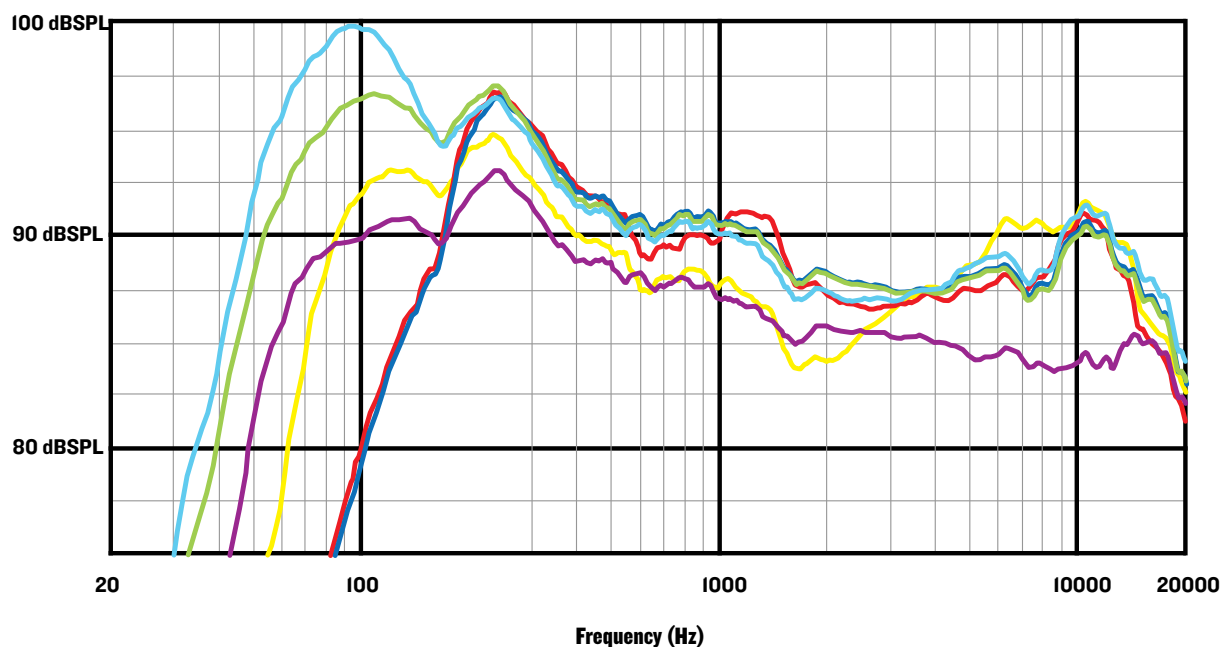

Thump12BST / Thump15BST Loudspeakers Block Diagram

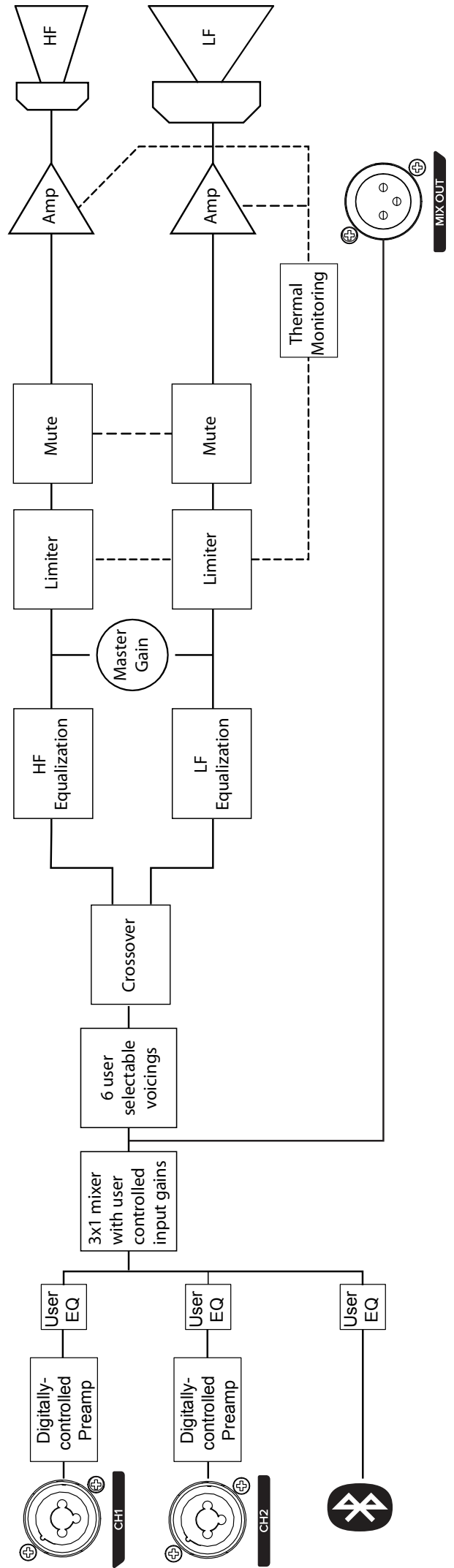

Please keep your sales receipt in a safe place.

This Limited Product Warranty ("Product Warranty") is provided by LOUD Technologies Inc. ("LOUD") and is applicable to products purchased in the United States or Canada through a LOUD-authorized reseller or dealer. The Product Warranty will not extend to anyone other than the original purchaser of the product (hereinafter, "Customer," "you" or "your").

For products purchased outside the U.S. or Canada, please visit www.mackie.com to find contact information for your local distributor, and information on any warranty coverage provided by the distributor in your local market.

LOUD warrants to Customer that the product will be free from defects in materials and workmanship under normal use during the Warranty Period. If the product fails to conform to the warranty then LOUD or its authorized service representative will at its option, either repair or replace any such nonconforming product, provided that Customer gives notice of the noncompliance within the Warranty Period to the Company at: www.mackie.com or by calling LOUD technical support at 1.800.898.3211 (toll-free in the U.S. and Canada) during normal business hours Pacific Time, excluding weekends or LOUD holidays. Please retain the original dated sales receipt as evidence of the date of purchase. You will need it to obtain any warranty service.

For full terms and conditions, as well as the specific duration of the Warranty for this product, please visit www.mackie.com.

The Product Warranty, together with your invoice or receipt, and the terms and conditions located at www.mackie.com constitutes the entire agreement, and supersedes any and all prior agreements between LOUD and Customer related to the subject matter hereof. No amendment, modification or waiver of any of the provisions of this Product Warranty will be valid unless set forth in a written instrument signed by the party to be bound thereby.

Need help with the loudspeaker?

- Visit www.mackie.com/support to find: FAQs, manuals, addendums, and other documents.
- Email us at: www.mackie.com/support-contact
- Telephone 1-800-898-3211 to speak with one of our splendid technical support chaps (Monday through Friday, normal business hours, Pacific Time).



**16220 Wood-Red Road NE
Woodinville, WA 98072 • USA
Phone: 425.487.4333
Toll-free: 800.898.3211
Fax: 425.487.4337
www.mackie.com**
