



Waterproof Mountable Outdoor Bluetooth® Speakers

BLACK

iHSI-W400BT-PR-BLK

iHSI-W525BT-PR-BLK

iHSI-W650BT-PR-BLK

WHITE

iHSI-W400BT-PR-WHT

iHSI-W525BT-PR-WHT

iHSI-W650BT-PR-WHT

©2021 Innovative Concepts & Design, LLC. All Rights Reserved.
iHome is a registered trademark of SDI Technologies Inc. Used Under License.
Bluetooth® is a registered trademark of Bluetooth SIG Inc.
Product specifications and colors may vary from photo.

Manufactured and serviced by:
Innovative Concepts & Design, LLC.
458 Florida Grove Road
Perth Amboy, NJ 08861 USA
(732) 587-5466

iHomePartyAudio.com

INDEX

What's Included	2
Precautions	3
Features	4
Product Overview	5
Specifications	8
FCC Compliance Statement	9
Legality & Safety	10
Warranty & Repair	11
Información en Español	12
Informations en Français	19
Informationen auf Deutsch	24
Informazioni in Italiano	29
Informatie in het Nederlands	34

What's Included

Please ensure that you find these accessories with your iHSI Bluetooth Speakers

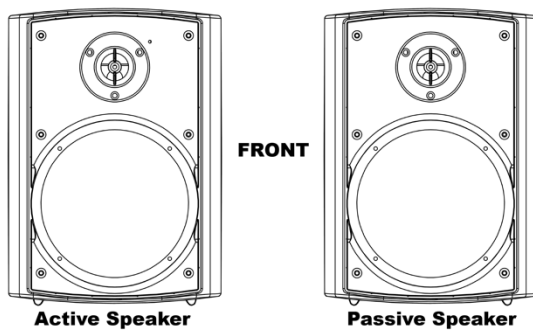

- (1) Active Speaker with Bracket
- (1) Passive Speaker with Bracket
- (1) AC Adapter
- (1) Speaker Cable

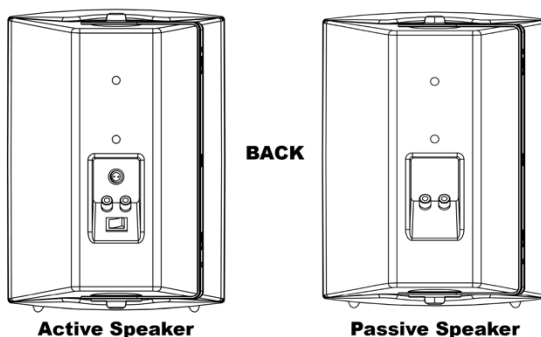

AC Adapter



Moisture Proof
Speaker Cable

PRECAUTIONS

PLEASE READ THESE INSTRUCTIONS GIVEN IN THIS MANUAL AND THOSE MARKED ON THE UNIT

This set has been designed and manufactured to assure personal safety. Improper use can result in electric shock or fire hazard. The safeguards incorporated in this unit will protect you if you observe the following procedures for installation, use and servicing. This unit is fully transistorized and does not contain any parts that can be repaired by the user.

WARNINGS

Fire and Electric Shock Hazard

- 1 - Do not place any open flame sources, such as lighted candles, on or near the apparatus.
- 2 - Do not attempt to service the apparatus yourself.
- 3 - Opening or removing covers may expose you to dangerous voltages or other hazards and will void the manufacturer's warranty.
- 4 - To prevent risk of fire or electric shock, avoid overloading wall outlets, extension cords, or integral convenience receptacles.
- 5 - Lightning storms Unplug this apparatus during lightning storms.
- 6- Object and liquid entry: Never insert objects of any kind through the openings of this apparatus, as it may touch dangerous voltage points or short-circuit parts that could result in a fire or electric shock. Care should be taken so that objects do not fall and liquids are not spilled into the apparatus through openings in the enclosure

FEATURES

The ultimate solution for your outdoor Bluetooth® audio needs. These mountable speakers are ideal for Backyards and Patios, whether for home or business use. You can even install these speakers on a boat! With a waterproof rating of IP44, you won't have to worry about leaving your speakers installed outside in the elements, they are safe from water and dust. Adjustable mounting brackets make for easy installation and allow for optimal sound dispersion. The iHSI Series Outdoor Speakers pair to your Bluetooth device with ease and the wireless remote puts the control in your hands. These speakers are specifically tuned for outdoor use, resulting in huge sound from a compact package so you can fill your Pool Parties, BBQs or any other outdoor event with unrivaled sound, sure to impress your guests

ALL WEATHER OUTDOOR SPEAKER

With a rating of IP44, the iHSI Series is water and dust resistant, specially designed to withstand most environments.

ACTIVE/PASSIVE SPEAKER PAIR

Includes one active speaker and one passive speaker, connect with included speaker wire. Only the active speaker will need to be connected to power.

BLUETOOTH®

Super simple wireless connection. Once you connect your preferred device via Bluetooth®, it will automatically connect in the future. LED indicator displays connection status.

REMOTE CONTROL

The included wireless remote puts the control in your hands. Remote allows you to Power on/off, Pair, Mute and adjust Volume, EQ and Playback controls.

BIG SOUND, COMPACT PACKAGE

D Class amplifier specifically tuned for outdoor use and custom cabinet tooling design.

SPEAKER INSTALLATION

These indoor/outdoor weatherproof speakers are manufactured to resist a variety of weather conditions including Snow, rain and sun (but not to be submerged under water.) For durability / longevity, we recommend removing the speakers from the brackets and storing indoors during extended extreme temperatures over 120° F and below 0° F. The most ideal place to install these speakers is under overhangs, as they provide the best protection. Like all speakers, they sound the best when placed no more than eight feet apart from each other, and slightly higher than ear level. When choosing the speaker placement - consider the location of the power source. The powered speaker should be placed near the power source. The passive speaker may be placed further away and should be connected to the powered speaker with included wire.

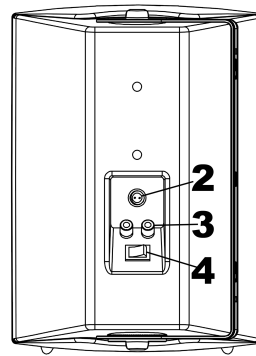
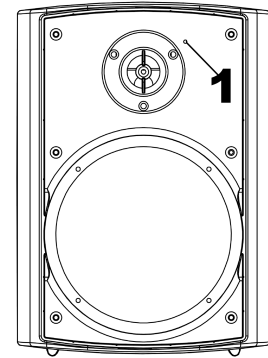

- 1: LED INDICATOR**
- 2: POWER PORT**
- 3: SPEAKER OUTPUT**
- 4: ON/OFF SWITCH**

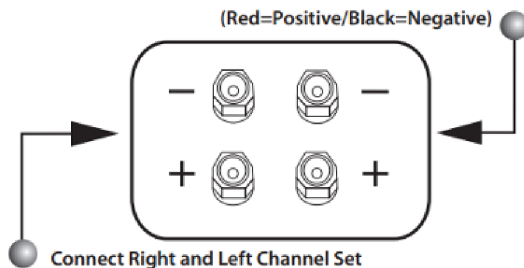

To connect Speaker Wire to Speaker:
 Unscrew the terminal.
 Insert appropriate wire below.
 Tighten to secure.

WIRING

When connecting the speakers, it is very important to connect with correct polarity. This means that the wire attached to the Red / Positive (+) terminal on one component must be attached to the Red / Positive (+) terminal on the corresponding component speaker terminal. Similarly, the Black / Negative / Ground (-) terminals must connect to the respective Black / Negative / Ground (-) terminals. This is easy to do by locating the (+) & (-) labels that appear on the included speaker wire. If longer wire run is needed, use 16-gauge weatherproof wire up to 50 feet.

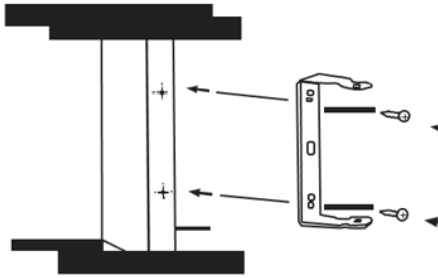

Placing Speakers

If your application requires the speaker to be mounted, please follow these directions. Using the appropriate screws (not included) mount the bracket. Attach the speakers to the brackets using the large plastic knobs supplied.

Mounting

To install the bracket on the speaker. Screw the bracket knobs into the cabinet. Point the speaker toward the listening area. Once the direction of the speaker has been determined tighten the bracket knobs securely. When possible, tilt the speakers down to increase longevity and prevent from the weather elements.

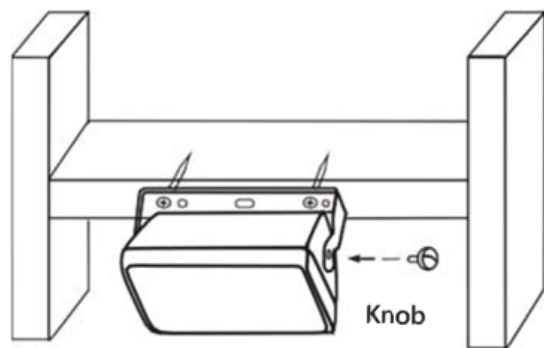

Method of Use

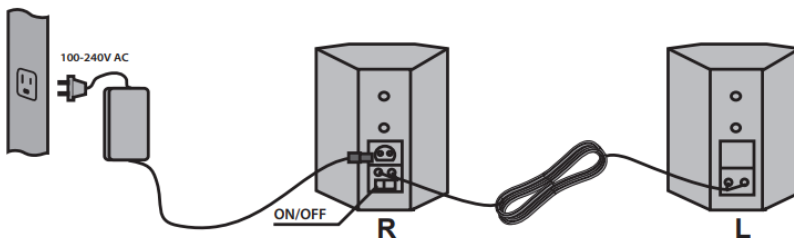

Bluetooth™



BLUETOOTH PAIRING NAMES

- iHome iHSI-400BT
- iHome iHSI-525BT
- iHome iHSI-650BT

Initial Setup

- Turn ON Bluetooth Device
- Open the Bluetooth Settings
- Select appropriate Bluetooth ID for connection
(You will hear Voice Prompt confirmation)
- You can now play Audio from your paired device
- Control Volume via Bluetooth Device or Remote

For subsequent pairings, Bluetooth will connect automatically when your Device is nearby with Bluetooth turned ON.

To connect another device, turn Bluetooth OFF on your original device.

STANDBY

After 10 minutes with no audio signal, speaker will automatically enter standby mode. Press the power button of remote to turn back on. Speaker will automatically reconnect to the last device in memory.

REMOTE

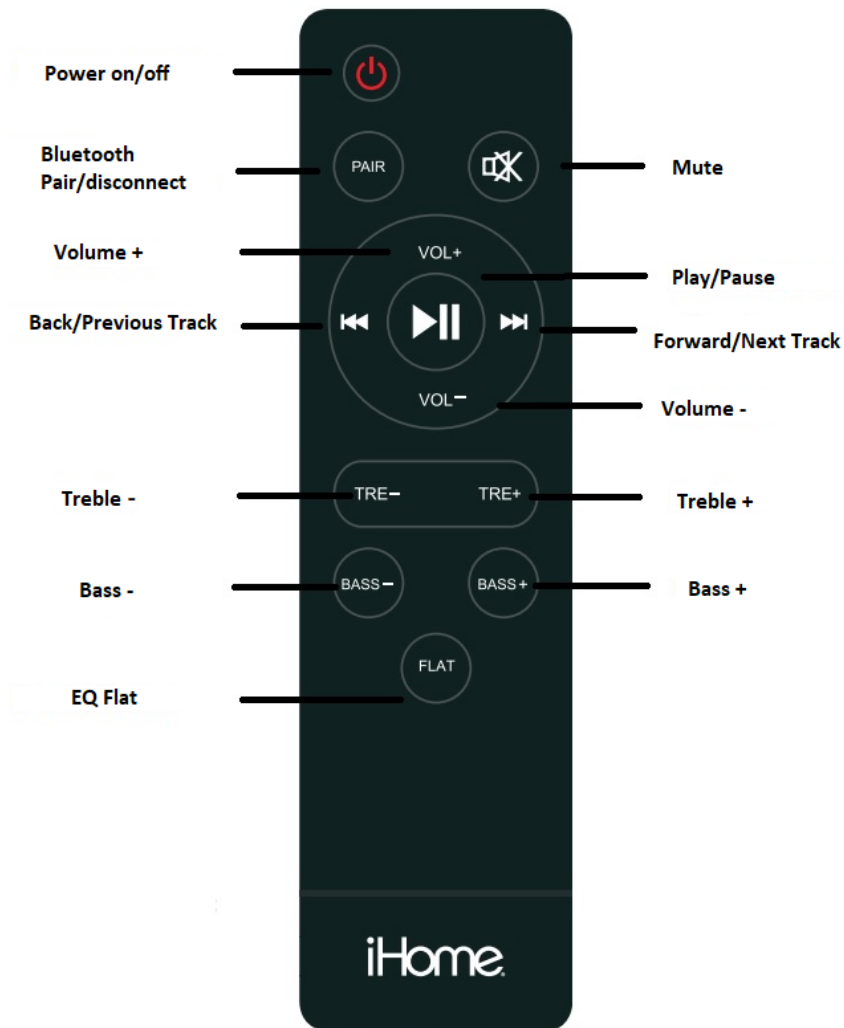

VOICE PROMPTS WORDS:

- Power On
- Connected
- Disconnected

SPECIFICATIONS

SPECIFICATIONS	Indoor/Outdoor Weatherproof Loudspeaker
<i>PART NUMBER:</i>	IHSI-W400BT-PR-BLK / IHSI-W400BT-PR-WHT
<i>BLUETOOTH:</i>	Bluetooth Specification 4.1+A2DP
<i>AUDIO INPUTS:</i>	Bluetooth Compatible Devices
<i>ACOUSTIC OUTPUT:</i>	2 x 12W RMS / 24W Music Power
<i>AUDIO POWER:</i>	AC100-240V
<i>WOOFER:</i>	4" Injection Molded PP Cone Butyl Rubber Surround
<i>TWEETER:</i>	1" PET Dome
<i>PACK DIMENSIONS:</i>	36.7X25.8X22.2cm (pair)
<i>PACK WEIGHT:</i>	4.6kgs (pair)
<i>COLOR:</i>	Black/White

SPECIFICATIONS	Indoor/Outdoor Weatherproof Loudspeaker
<i>PART NUMBER:</i>	IHSI-W525BT-PR-BLK / IHSI-W525BT-PR-WHT
<i>BLUETOOTH:</i>	Bluetooth Specification 4.1+A2DP
<i>AUDIO INPUTS:</i>	Bluetooth Compatible Devices
<i>ACOUSTIC OUTPUT:</i>	2 x 15W RMS / 30W Music Power
<i>AUDIO POWER:</i>	AC100-240V
<i>WOOFER:</i>	5.25" Injection Molded PP Cone Butyl Rubber Surround
<i>TWEETER:</i>	0.75" PET Dome
<i>PACK DIMENSIONS:</i>	40.5X28X23.5cm (pair)
<i>PACK WEIGHT:</i>	5.26kgs (pair)
<i>COLOR:</i>	Black/White

SPECIFICATIONS	Indoor/Outdoor Weatherproof Loudspeaker
<i>PART NUMBER:</i>	IHSI-W650BT-PR-BLK / IHSI-W650BT-PR-WHT
<i>BLUETOOTH:</i>	Bluetooth Specification 4.1+A2DP
<i>AUDIO INPUTS:</i>	Bluetooth Compatible Devices
<i>ACOUSTIC OUTPUT:</i>	2 x 20W RMS / 40W Music Power
<i>AUDIO POWER:</i>	AC100-240V
<i>WOOFER:</i>	6.50" Injection Molded PP Cone Butyl Rubber Surround
<i>TWEETER:</i>	1" PET Dome
<i>PACK DIMENSIONS:</i>	46X33X25cm (pair)
<i>PACK WEIGHT:</i>	7.0kgs (pair)
<i>COLOR:</i>	White/Black

Responsible Party Name:

Innovative Concepts & Design LLC

Company address:

458 Florida Grove Road
Perth Amboy, NJ, 08861 USA

FCC Compliance Statement

This device complies with Part 15 of the FCC Rules. The operation is subject to the following two conditions:

- (1) This device may not cause harmful interference, and
- (2) This device must accept any interference received, including interference that may cause undesired operation.

Note: This equipment has been tested and found to comply with the limits for a class B digital device, pursuant to Part 15 of the FCC Rules. This equipment generates, uses and can radiate radio frequency energy and if not installed and used in accordance with the instructions, may cause harmful interference to radio communications. However, there is no guarantee that interference will not occur in a particular installation. If this equipment does cause interference to radio or television reception, which can be determined by turning the equipment off and then on, the user is encouraged to try to correct the interference by one or more of the following measures:

- Reorient or relocate the receiving antenna.
- Increase the separation between the equipment and receiver.
- Connect the equipment to a different outlet so that the equipment and receiver are on different branch circuits.
- Consult the dealer or an experienced radio/TV technician for help.

FCC ID: 2AWFXIHSI650BT

LEGALITY & SAFETY

The device is not intended for use by people (including children) with reduced physical, sensory or mental capacity. People who have not read the manual, unless they have received an explanation by someone responsible for their safety, should not use this unit. Children should be monitored to ensure that they do not play with the device. The device should always be readily accessible. The device should not be exposed to water. No objects filled with liquids, such as vases, shall be placed on the device. Always leave a minimum distance of 10 cm around the unit to ensure sufficient ventilation. Open flame sources, such as candles, should not be placed on top of the device. The device is intended for use only in a temperate climate. At full volume, prolonged listening may damage your hearing and cause temporary or permanent deafness, hearing drone, tinnitus, or hyperacusis. Listening at high volume is not recommended. One hour per day is not recommended either. Danger of explosion if battery is incorrectly replaced or not replaced by the same type or equivalent. The battery should not be exposed to excessive heat such as sunshine or fire. Different types of batteries, or new and used batteries, should not be mixed. The battery must be installed according to its polarity. If the battery is worn, it must be removed from the product. The battery must be disposed of safely. Always use collection bins to protect the environment. The battery can only be replaced by the maker of this product, the sales department, or a qualified person. Switch the device off where the use of the device is not allowed or where there is a risk of causing interference or danger - for examples: on an aircraft, or near medical equipment, fuel, chemicals or blasting sites. Check the current laws and regulations regarding the use of this device in the areas where you drive. Do not handle the device when driving. Concentrate fully on driving. All wireless devices are susceptible to interference which may affect their performance. All our devices conform to international/national standards and regulations, and we aim to limit user exposure to electromagnetic fields. These standards and regulations were adopted after the completion of extensive scientific research. This research established no link between the use of the mobile headset and any adverse effects on health if the device is used in accordance with standard practices. Only qualified people are authorized to install or repair this product. Only use batteries, chargers and other accessories which are compatible with this equipment. Do not connect incompatible products. This equipment is not waterproof. Keep it dry. Keep your device in a safe place, out of the reach of young children. The device contains small parts which may present a choking hazard to kids.

WARRANTY AND REPAIR:

All Innovative Concepts & Design LLC products are designed and manufactured to the highest standards in the industry. With proper care and maintenance, your product will provide years of reliable service.

LIMITED WARRANTY

A. Innovative Concepts & Design LLC guarantees its products to be free from defects in materials and workmanship for one (1) year from the original purchase date. Exceptions: Laser assemblies on CD Players, cartridges, and crossfaders are covered for 90 days.

B. This limited warranty does not cover damage or failure caused by abuse, misuse, abnormal use, faulty installation, improper maintenance or any repairs other than those provided by an authorized Innovative Concepts & Design LLC Service Center.

C. There are no obligations of liability on the part of Innovative Concepts & Design LLC for consequential damages arising out of or in connection with the use or performance of the product or other indirect damages with respect to loss of property, revenues, of profit, or costs of removal, installation, or reinstallation. All implied warranties for Innovative Concepts & Design LLC, including implied warranties for fitness, are limited in duration to one (1) year from the original date of purchase, unless otherwise mandated by local statutes.

RETURN/REPAIR

A. In the U.S.A., please call our helpful Customer Service Representatives at (732) 346-0061, and they will be happy to give you a Return Authorization Number (RA#) and the address of an authorized service center closest to you.

B. After receiving an RA#, include a copy of the original sales receipt, with defective product and a description of the defect. Send by insured freight to: Innovative Concepts & Design LLC and use the address provided by your customer service representative. Your RA# must be written on the outside of the package, or processing will be delayed indefinitely!

C. Service covered under warranty will be paid for by Innovative Concepts & Design LLC and returned to you. For non-warranted products, Innovative Concepts & Design LLC will repair your unit after payment is received. Repair charges do not include return freight. Freight charges will be added to the repair charges.

D. On warranty service, you pay for shipping to Innovative Concepts & Design LLC, we pay for return shipping within the continental United States. Alaska, Hawaii, Puerto Rico, Canada, Bahamas, and the Virgin Islands will be charged for freight.

E. Please allow 2-3 weeks for return of your product.

Under normal circumstances your product will spend no more than 10 working days at Innovative Concepts & Design LLC. We are not responsible for shipping times.

iHome



Altavoces Bluetooth® para exteriores impermeables y montables

NEGRO

iHSI-W400BT-PR-BLK

iHSI-W525BT-PR-BLK

iHSI-W650BT-PR-BLK

BLANCO

iHSI-W400BT-PR-WHT

iHSI-W525BT-PR-WHT

iHSI-W650BT-PR-WHT

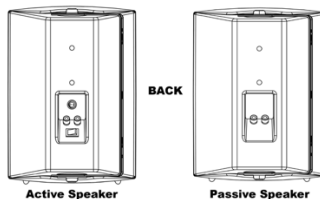
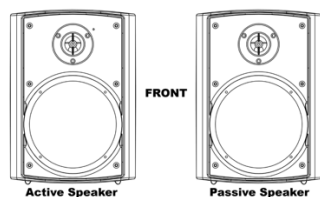

Qué está incluido

Asegúrese de encontrar estos accesorios con sus altavoces Bluetooth IHSI

- (1) Altavoz autoamplificado con soporte
- (1) Altavoz pasivo con soporte
- (1) Adaptador de CA
- (1) Cable de altavoz

PRECAUCIONES

POR FAVOR LEA ESTAS INSTRUCCIONES DADAS EN ESTE MANUAL Y LAS MARCADAS EN LA UNIDAD

Este conjunto ha sido diseñado y fabricado para garantizar la seguridad personal. El uso inadecuado puede provocar descargas eléctricas o peligro de incendio. Las medidas de seguridad incorporadas en esta unidad lo protegerán si observa los siguientes procedimientos de instalación, uso y servicio. Esta unidad está completamente transistorizada y no contiene ninguna pieza que pueda ser reparada por el usuario.

ADVERTENCIAS

Peligro de incendio y descarga eléctrica

- 1 - No coloque ninguna fuente de llama abierta, como velas encendidas, sobre o cerca del aparato.
- 2 - No intente reparar el aparato usted mismo.
- 3 - Abrir o quitar las cubiertas puede exponerlo a voltajes peligrosos u otros peligros y anulará la garantía del fabricante.
- 4 - Para evitar el riesgo de incendio o descarga eléctrica, evite sobrecargar los tomacorrientes de pared, los cables de extensión o los receptáculos de conveniencia integrales.
- 5 - Tormentas eléctricas Desenchufe este aparato durante tormentas eléctricas.
- 6- Entrada de objetos y líquidos: Nunca inserte objetos de ningún tipo a través de las aberturas de este aparato, ya que pueden tocar puntos de voltaje peligrosos o cortocircuitar partes que podrían resultar en un incendio o descarga eléctrica. Se debe tener cuidado para que no caigan objetos y no se derramen líquidos dentro del aparato a través de las aberturas de la carcasa.

CARACTERÍSTICAS

La solución definitiva para sus necesidades de audio Bluetooth® para exteriores. Estos altavoces montables son ideales para patios y patios, ya sea para uso doméstico o comercial. ¡Incluso puedes instalar estos altavoces en un barco! Con una clasificación de resistencia al agua de IP44, no tendrá que preocuparse por dejar los altavoces instalados en el exterior en los elementos, están a salvo del agua y el polvo. Los soportes de montaje ajustables facilitan la instalación y permiten una óptima dispersión del sonido. El IPHA-W400BT se empareja con su dispositivo Bluetooth con facilidad y el control remoto inalámbrico pone el control en sus manos. Estos parlantes están específicamente sintonizados para uso en exteriores, lo que da como resultado un sonido enorme en un paquete compacto para que pueda llenar sus fiestas en la piscina, barbacoas o cualquier otro evento al aire libre con un sonido inigualable, que seguramente impresionará a sus invitados.

ALTAVOZ PARA TODO EL TIEMPO AL AIRE LIBRE

Con una clasificación de IP44, los iHSI es resistente al agua y al polvo, especialmente diseñado para soportar la mayoría de los entornos.

PAR DE ALTAVOCES ACTIVOS / PASIVOS

Incluye un altavoz maestro activo y un altavoz esclavo pasivo, se conectan con el cable de altavoz incluido. Solo el altavoz principal deberá estar conectado a la alimentación.

BLUETOOTH®

Conexión inalámbrica súper simple. Una vez que conecte su dispositivo preferido a través de Bluetooth®, se conectará automáticamente en el futuro. El indicador LED muestra el estado de la conexión.

CONTROL REMOTO

El control remoto inalámbrico incluido pone el control en sus manos. El control remoto le permite encender / apagar, emparejar, silenciar y ajustar los controles de volumen, ecualización y reproducción.

GRAN SONIDO, PAQUETE COMPACTO

Amplificador de clase D sintonizado específicamente para uso en exteriores y diseño de herramientas de gabinete personalizado.

Instalación de altavoces

Estos altavoces resistentes a la intemperie para interiores y exteriores están fabricados para resistir una variedad de condiciones climáticas. Nieve, lluvia y sol (no sumergir bajo el agua). Para mayor durabilidad / longevidad, recomendamos quitar los altavoces de los soportes y colocarlos en el interior durante temperaturas extremas prolongadas de más de 120 grados y menos de 0 grados. El lugar más ideal para instalar estos altavoces es debajo de los voladizos, ya que brindan la mejor protección. Como todos los altavoces, suenan mejor cuando se colocan a no más de dos metros y medio de distancia entre sí y un poco más altos que el nivel de los oídos. Al elegir la ubicación de los altavoces, tenga en cuenta la ubicación de la fuente de alimentación. El altavoz autoamplificado debe colocarse cerca de la fuente de alimentación. El altavoz pasivo puede colocarse más lejos y debe conectarse al altavoz autoamplificado.

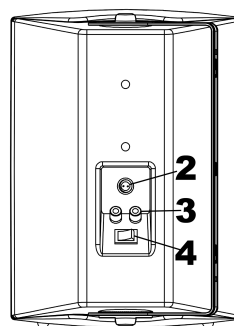
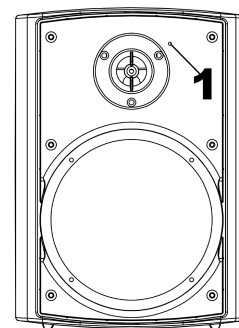

- 1: LED
- 2: DC IN (ALIMENTACIÓN)
- 3: SALIDA DE ALTAVOZ DERECHO
- 4: INTERRUPTOR DE ENCENDIDO / APAGADO

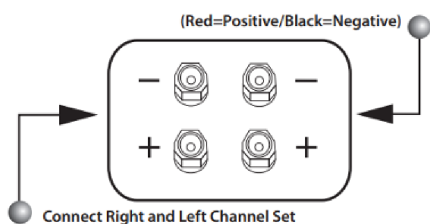

Para conectar el cable del altavoz al altavoz:
Desatornille el terminal.
Inserte el cable apropiado a continuación.
Apriete para asegurar.

ALAMBRADO

Al conectar los altavoces, es muy importante observar la polaridad correcta. Esto significa que el cable conectado a los terminales (+), rojo o positivo de un componente debe conectarse al terminal (+), rojo o positivo de los terminales de salida de altavoz del componente correspondiente. De manera similar, los terminales (-), Negro, Negativo o de tierra deben conectarse a los respectivos terminales (-), Negro, Negativo o de tierra. Esto es fácil de hacer localizando las franjas de color que aparecen en el cable de altavoz incluido. Si se necesita un tramo de cable más largo, use cable resistente a la intemperie de calibre 16 hasta 50 pies.

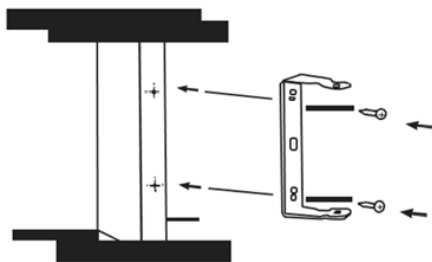

Colocación de altavoces

Si su aplicación requiere que se monte el altavoz, siga estas instrucciones. Usando los tornillos apropiados (no incluidos) monte el soporte. Fije los altavoces a los soportes utilizando las perillas de plástico grandes suministradas.

Montaje

Para instalar el soporte en el altavoz. Atornille las perillas del soporte en el gabinete. Apunte el altavoz hacia el área de audición. Una vez que se ha determinado la dirección del altavoz, apriete firmemente las perillas del soporte. Cuando sea posible, incline los altavoces hacia abajo para aumentar la longevidad y evitar las inclemencias del tiempo.

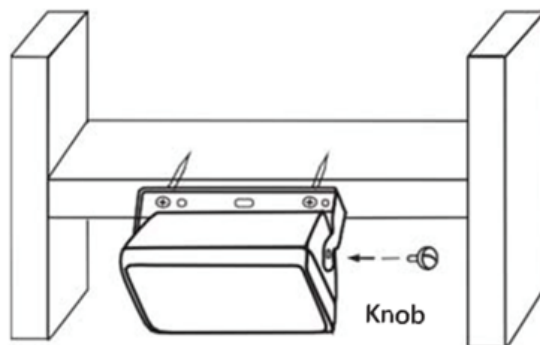

Metodo de uso

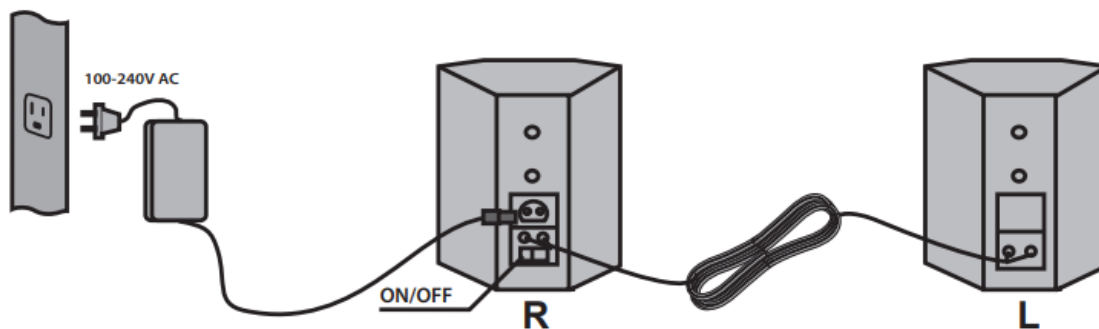

NOMBRES DE EMPAREJAMIENTO DE BLUETOOTH:

- iHome iHSI-400BT
- iHome iHSI-525BT
- iHome iHSI-650BT

Configuración inicial

- Encienda el dispositivo Bluetooth
- Abra la configuración de Bluetooth
- Seleccione el ID de Bluetooth apropiado para la conexión (Escuchará la confirmación del mensaje de voz)
- Ahora puede reproducir audio desde su dispositivo emparejado
- Control de volumen mediante dispositivo Bluetooth o control remoto

Para emparejamientos posteriores, Bluetooth se conectará automáticamente cuando su dispositivo esté cerca con Bluetooth encendido. Para conectar otro dispositivo, apague Bluetooth en su dispositivo original.

APOYAR

Si no hay entrada de señal en 10 minutos, ingresará automáticamente al modo de espera. El usuario puede presionar el botón de encendido del control remoto para regresarlo. se volverá a conectar automáticamente al último dispositivo en la memoria.

REMOTO

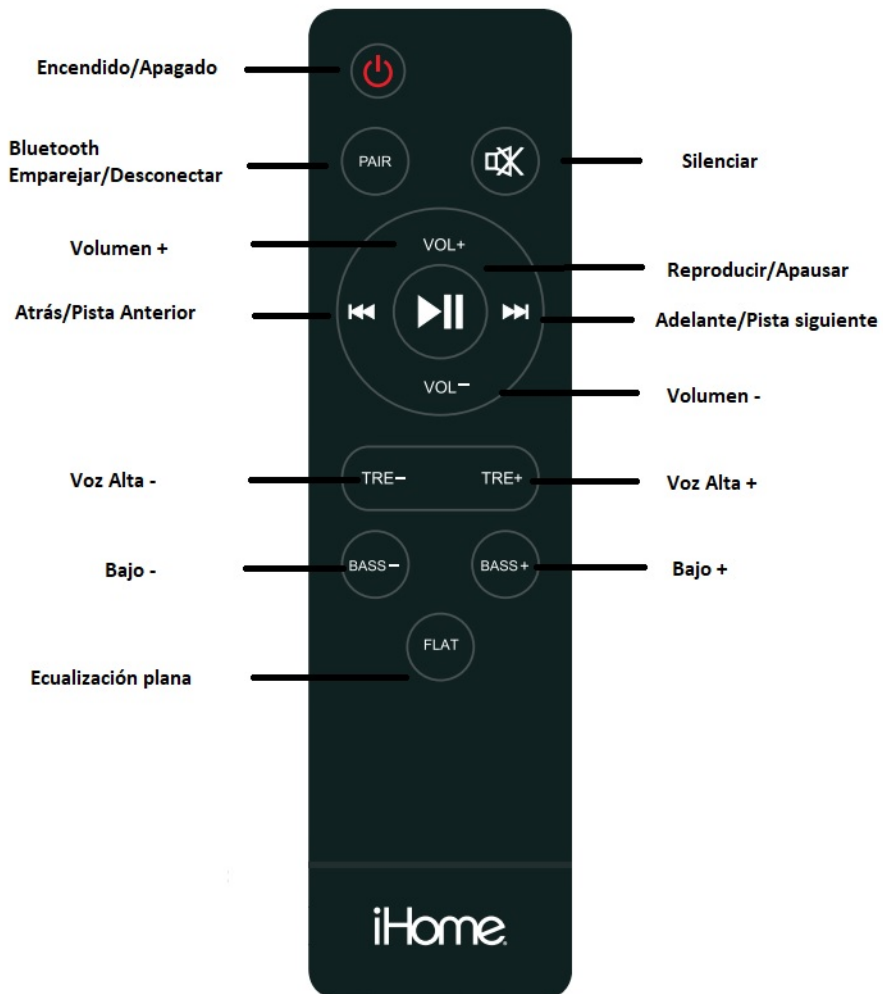

PALABRAS DE AVISOS DE VOZ:

- “Power On” = Encendido
- “Connected” = Conectado
- “Disconnected” = Desconectado

ESPECIFICACIONES

ESPECIFICACIONES	Altavoz resistente a la intemperie para interiores / exteriores
<i>NÚMERO DE PIEZA:</i>	IHSI-W400BT-PR-BLK / IHSI-W400BT-PR-WHT
<i>PROTOCOLO BLUETOOTH:</i>	Especificación Bluetooth 4.1 + A2DP ENTRADAS DE
<i>AUDIO:</i>	Dispositivos compatibles con Bluetooth
<i>POTENCIA DE SALIDA</i>	2 x 12W RMS / 24W Music Power
<i>POTENCIA DE AUDIO:</i>	AC100-240V
<i>WOOFER:</i>	Anillo de caucho butílico de cono de PP moldeado por inyección de 4 "
<i>TWEETER:</i>	domo PET de 1 "
<i>DIMENSIONES DEL PAQUETE</i>	36.7X25.8X22.2cm (par)
<i>PESO DEL PAQUETE</i>	4.6 kgs (par)
<i>COLOR:</i>	Negro / Blanco

ESPECIFICACIONES	Altavoz resistente a la intemperie para interiores / exteriores
<i>NÚMERO DE PIEZA:</i>	IHSI-W525BT-PR-BLK / IHSI-W525BT-PR-WHT
<i>PROTOCOLO BLUETOOTH:</i>	Especificación Bluetooth 4.1 + A2DP ENTRADAS DE
<i>AUDIO:</i>	Dispositivos compatibles con Bluetooth
<i>POTENCIA DE SALIDA</i>	2 x 15W RMS / 30W Music Power
<i>POTENCIA DE AUDIO:</i>	AC100-240V
<i>WOOFER:</i>	Anillo de caucho butílico de cono de PP moldeado por inyección de 4 "
<i>TWEETER:</i>	domo PET de 1 "
<i>DIMENSIONES DEL PAQUETE</i>	39.5X27X22.5cm (par)
<i>PESO DEL PAQUETE</i>	4.97 kgs (par)
<i>COLOR:</i>	Negro / Blanco

ESPECIFICACIONES	Altavoz resistente a la intemperie para interiores / exteriores
<i>NÚMERO DE PIEZA:</i>	IHSI-W650BT-PR-BLK / IHSI-W650BT-PR-WHT
<i>PROTOCOLO BLUETOOTH:</i>	Especificación Bluetooth 4.1 + A2DP ENTRADAS DE
<i>AUDIO:</i>	Dispositivos compatibles con Bluetooth
<i>POTENCIA DE SALIDA</i>	2 x 20W RMS / 40W Music Power
<i>POTENCIA DE AUDIO:</i>	AC100-240V
<i>WOOFER:</i>	Anillo de caucho butílico de cono de PP moldeado por inyección de 4 "
<i>TWEETER:</i>	domo PET de 1 "
<i>DIMENSIONES DEL PAQUETE</i>	45X32.5X24.5cm (par)
<i>PESO DEL PAQUETE</i>	6.5 kgs (par)
<i>COLOR:</i>	Negro / Blanco

FONCTIONNALITÉS

La solution ultime pour vos besoins audio Bluetooth® extérieurs. Ces haut-parleurs montables sont idéaux pour les arrière-cours et les patios, que ce soit pour un usage domestique ou professionnel. Vous pouvez même installer ces haut-parleurs sur un bateau! Avec un indice d'étanchéité IP44, vous n'aurez pas à vous soucier de laisser vos haut-parleurs installés à l'extérieur dans les éléments, ils sont à l'abri de l'eau et de la poussière. Les supports de montage réglables facilitent l'installation et permettent une dispersion optimale du son. Les haut-parleurs extérieurs de la série iHSI s'associent facilement à votre appareil Bluetooth et la télécommande sans fil met le contrôle entre vos mains. Ces haut-parleurs sont spécialement réglés pour une utilisation en extérieur, ce qui donne un son énorme à partir d'un ensemble compact afin que vous puissiez remplir vos fêtes à la piscine, barbecues ou tout autre événement en plein air avec un son inégalé, sûr d'impressionner vos invités

HAUT-PARLEUR EXTÉRIEUR PAR TOUS LES TEMPS

Avec un indice de protection IP44, la série iHSI est résistante à l'eau et à la poussière, spécialement conçue pour résister à la plupart des environnements.

PAIRE DE HAUT-PARLEURS ACTIFS/PASSIFS

Comprend un haut-parleur actif et un haut-parleur passif, connectez-vous avec le fil de haut-parleur inclus. Seul le haut-parleur actif devra être connecté à l'alimentation.

BLUETOOTH®

Connexion sans fil super simple. Une fois que vous avez connecté votre appareil préféré via Bluetooth®, il se connectera automatiquement à l'avenir. L'indicateur LED affiche l'état de la connexion.

TÉLÉCOMMANDE

La télécommande sans fil incluse met le contrôle entre vos mains. La télécommande vous permet d'allumer / éteindre, de coupler, de couper le son et de régler les commandes de volume, d'égalisation et de lecture.

GROS SON, BOÎTIER COMPACT

Amplificateur de classe D spécialement réglé pour une utilisation en extérieur et une conception d'outillage d'armoire personnalisée.

INSTALLATION DE HAUT-PARLEURS

Ces haut-parleurs résistants aux intempéries intérieurs / extérieurs sont fabriqués pour résister à une variété de conditions météorologiques, y compris la neige, la pluie et le soleil (mais pas pour être immergés sous l'eau). Pour la durabilité / longévité, nous vous recommandons de retirer les haut-parleurs des supports et de les stocker à l'intérieur pendant des températures extrêmes prolongées supérieures à 120 ° F et inférieures à 0 ° F. L'endroit le plus idéal pour installer ces haut-parleurs est sous des porte-à-faux, car ils offrent la meilleure protection. Comme tous les haut-parleurs, ils sonnent mieux lorsqu'ils ne sont pas placés à plus de huit pieds les uns des autres et légèrement plus haut que le niveau de l'oreille. Lorsque vous choisissez l'emplacement du haut-parleur, tenez compte de l'emplacement de la source d'alimentation. Le haut-parleur alimenté doit être placé près de la source d'alimentation. Le haut-parleur passif peut être placé plus loin et doit être connecté au haut-parleur alimenté avec le fil inclus.

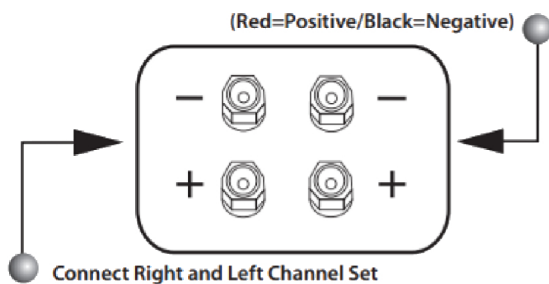

Pour connecter le fil de haut-parleur au haut-parleur:

- Dévisser la borne.
- Insérez le fil approprié ci-dessous.
- Serrez pour sécuriser.

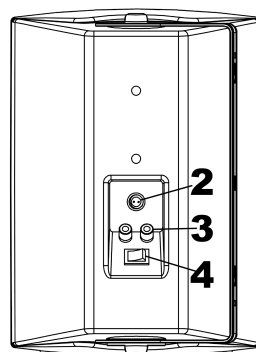
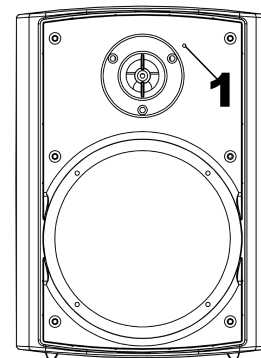

- 1: INDICATEUR LED**
- 2: PORT D'ALIMENTATION**
- 3 : SORTIE HAUT-PARLEUR**
- 4: INTERRUPTEUR MARCHÉ / ARRÊT**

CÂBLAGE

Lors de la connexion des haut-parleurs, il est très important de se connecter avec une polarité correcte. Cela signifie que le fil attaché à la borne Rouge / Positif (+) sur un composant doit être attaché à la borne Rouge / Positif (+) sur la borne de haut-parleur du composant correspondant. De même, les bornes Noire / Négative / Terre (-) doivent se connecter aux bornes Noire / Négative / Terre (-) respectives. Ceci est facile à faire en localisant les étiquettes (+) et (-) qui apparaissent sur le fil de haut-parleur inclus. Si un fil plus long est nécessaire, utilisez un fil résistant aux intempéries de calibre 16 jusqu'à 50 pieds.

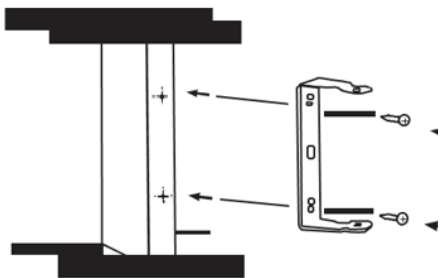

Placement des haut-parleurs

Si votre application nécessite le montage du haut-parleur, veuillez suivre ces instructions. À l'aide des vis appropriées (non incluses), montez le support. Fixez les haut-parleurs aux supports à l'aide des gros boutons en plastique fournis.

Montage

Pour installer le support sur le haut-parleur. Vissez les boutons du support dans l'armoire. Pointez le haut-parleur vers la zone d'écoute. Une fois que la direction du haut-parleur a été déterminée, serrez solidement les boutons du support. Lorsque cela est possible, inclinez les haut-parleurs vers le bas pour augmenter la longévité et éviter les intempéries.

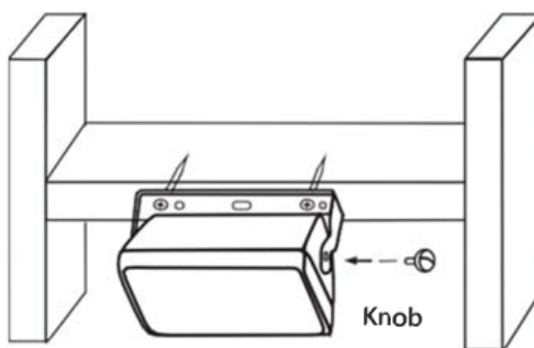

Method of Use

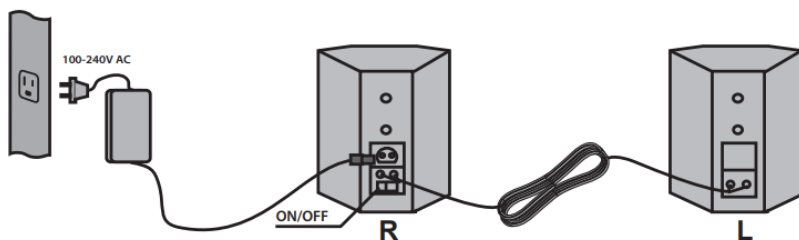

Configuration initiale

- Activer l'appareil Bluetooth
- Ouvrez les paramètres Bluetooth
- Sélectionnez l'ID Bluetooth approprié pour la connexion (vous entendrez la confirmation de l'invite Voice)
- Vous pouvez maintenant lire de l'audio à partir de votre appareil jumelé
- Contrôlez le volume via un périphérique Bluetooth ou une télécommande



BLUETOOTH PAIRING NAMES

- iHome iHSI-400BT
- iHome iHSI-525BT
- iHome iHSI-650BT

Pour les couplages suivants, Bluetooth se connecte automatiquement lorsque votre appareil est à proximité avec Bluetooth activé. Pour connecter un autre appareil, désactivez le Bluetooth sur votre appareil d'origine.

VEILLE

Après 10 minutes sans signal audio, le haut-parleur passera automatiquement en mode veille. Press le bouton d'alimentation de la télécommande pour le rallumer. Le haut-parleur se reconnectera automatiquement au dernier appareil en mémoire.

LOINTAIN

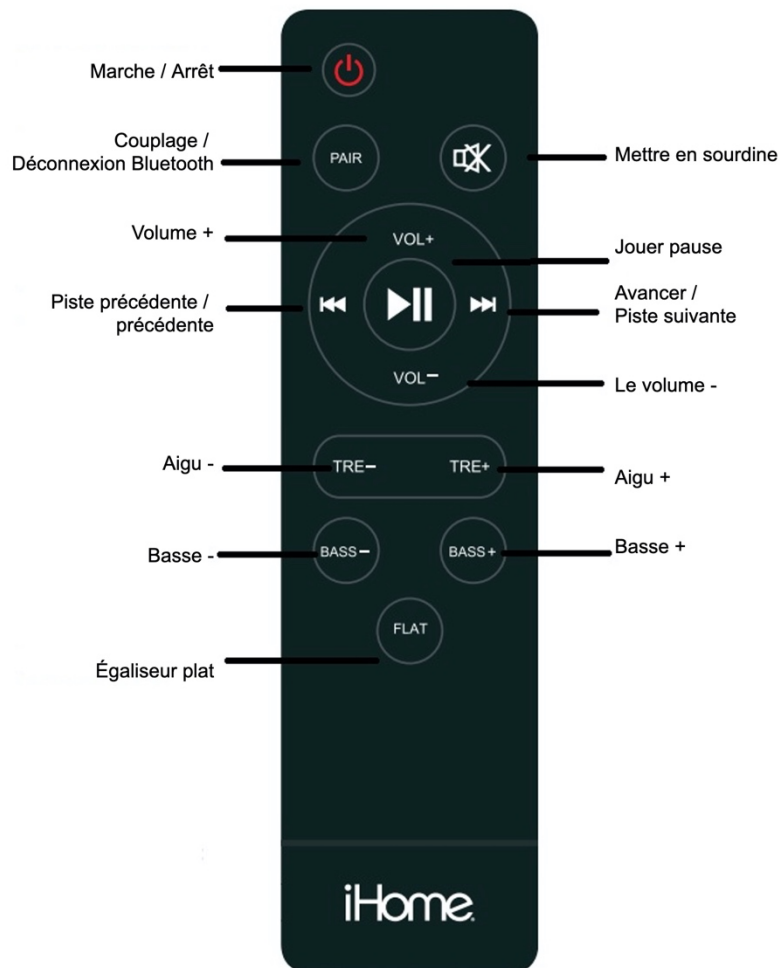

LA VOIX INVITE LES MOTS :

- Mise sous tension
- Relié
- Coupé

SPÉCIFICATIONS

SPÉCIFICATIONS	Haut-parleur intérieur / extérieur résistant aux
NUMÉRO DE PIÈCE :	IHSI-W400BT-PR-BLK / IHSI-W400BT-PR-WHT
BLUETOOTH :	Spécification Bluetooth 4.1 + A2DP
ENTRÉES AUDIO :	Appareils compatibles Bluetooth
SORTIE	2 x 12W RMS / 24W Puissance musicale
PUISSANCE AUDIO:	AC100-240V
WOOFER:	4 « Injection Molded PP Cone Butyl Rubber Surround
TWEETER:	Dôme PET 1 »
DIMENSIONS DE	36.7X25.8X22.2cm (paire)
POIDS DE	4.6kgs (paire)
COULEUR:	Noir/Blanc

SPÉCIFICATIONS	Haut-parleur intérieur / extérieur résistant aux
NUMÉRO DE PIÈCE :	IHSI-W525BT-PR-BLK / IHSI-W525BT-PR-WHT
BLUETOOTH :	Spécification Bluetooth 4.1 + A2DP
ENTRÉES AUDIO :	Appareils compatibles Bluetooth
SORTIE	2 x 15W RMS / 30W Puissance musicale
PUISSANCE AUDIO:	AC100-240V
WOOFER:	5.25 « Pp moulé par injection cône butyle caoutchouc
TWEETER:	Dôme PET de 0,75 po
DIMENSIONS DE	40.5X28X23.5cm (paire)
POIDS DE	5.26kgs (paire)
COULEUR:	Noir/Blanc

SPÉCIFICATIONS	Haut-parleur intérieur / extérieur résistant aux
NUMÉRO DE PIÈCE :	IHSI-W650BT-PR-BLK / IHSI-W650BT-PR-WHT
BLUETOOTH :	Spécification Bluetooth 4.1 + A2DP
ENTRÉES AUDIO :	Appareils compatibles Bluetooth
PUISSANCE DE	2 x 20W RMS / 40W Puissance musicale
PUISSANCE AUDIO:	AC100-240V
WOOFER:	6.50 « Injection Molded PP Cone Butyl Rubber Surround
TWEETER:	Dôme PET 1 »
DIMENSIONS DE	46X33X25cm (paire)
POIDS DE	7.0kgs (paire)
COULEUR:	Blanc/Noir

FUNKTIONEN

Die ultimative Lösung für Ihre Bluetooth-Audioanforderungen® im Freien. Diese montierbaren Lautsprecher sind ideal für Hinterhöfe und Terrassen, egal ob für zu Hause oder geschäftlich. Sie können diese Lautsprecher sogar auf einem Boot installieren! Mit einer wasserdichten Bewertung von IP44 müssen Sie sich keine Sorgen machen, dass Ihre Lautsprecher draußen in den Elementen installiert sind, sie sind sicher vor Wasser und Staub. Verstellbare Montagewinkel erleichtern die Installation und ermöglichen eine optimale Schallabstrahlung. Die Outdoor-Lautsprecher der iHSI-Serie lassen sich problemlos mit Ihrem Bluetooth-Gerät koppeln und die drahtlose Fernbedienung legt die Steuerung in Ihre Hände. Diese Lautsprecher sind speziell für den Außenbereich abgestimmt, was zu einem riesigen Klang aus einem kompakten Paket führt, so dass Sie Ihre Poolpartys, BBQs oder jede andere Outdoor-Veranstaltung mit unvergleichlichem Klang füllen können, der Ihre Gäste beeindrucken wird

ALL WEATHER OUTDOOR LAUTSPRECHER

Mit einer Schutzart von IP44 ist die iHSI-Serie wasser- und staubdicht und wurde speziell für die meisten Umgebungen entwickelt.

AKTIV/PASSIVES LAUTSPRECHERPAAR

Enthält einen aktiven Lautsprecher und einen passiven Lautsprecher, Anschluss mit mitgeliefertem Lautsprecherkabel. Nur der aktive Lautsprecher muss an die Stromversorgung angeschlossen werden.

BLUETOOTH®

Super einfache drahtlose Verbindung. Sobald Sie Ihr bevorzugtes Gerät über Bluetooth® verbunden haben, wird es in Zukunft automatisch eine Verbindung herstellen. LED-Anzeige zeigt den Verbindungsstatus an.

FERNBEDIENUNG

Die mitgelieferte Funkfernbedienung legt die Steuerung in Ihre Hände. Remote ermöglicht das Ein- / Ausschalten, Koppeln, Stummschalten und Anpassen von Lautstärke-, EQ- und Wiedergabesteuerungen.

GROSSER SOUND, KOMPAKTES GEHÄUSE

Verstärker der D-Klasse, der speziell für den Außenbereich und das Design kundenspezifischer Schrankwerkzeuge abgestimmt wurde.

LAUSPRECHER-INSTALLATION

Diese wetterfesten Lautsprecher für den Innen- und Außenbereich werden hergestellt, um einer Vielzahl von Wetterbedingungen wie Schnee, Regen und Sonne standzuhalten (aber nicht unter Wasser zu tauchen). Aus Gründen der Haltbarkeit / Langlebigkeit empfehlen wir, die Lautsprecher aus den Halterungen zu entfernen und bei längeren extremen Temperaturen über 120 ° F und unter 0 ° F in Innenräumen zu lagern. Der idealste Ort, um diese Lautsprecher zu installieren, ist unter Überhängen, da sie den besten Schutz bieten. Wie alle Lautsprecher klingen sie am besten, wenn sie nicht mehr als acht Fuß voneinander entfernt und etwas höher als das Ohrniveau platziert sind. Berücksichtigen Sie bei der Auswahl der Lautsprecherplatzierung die Position der Stromquelle. Der Aktivlautsprecher sollte in der Nähe der Stromquelle platziert werden. Der passive Lautsprecher kann weiter entfernt platziert werden und sollte mit dem mitgelieferten Kabel an den Aktivlautsprecher angeschlossen werden.

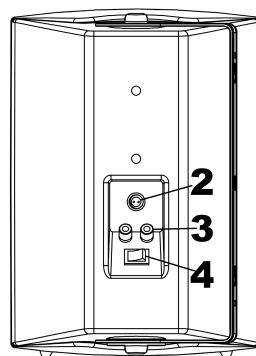
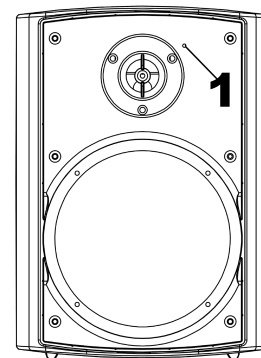

- 1: LED-ANZEIGE**
- 2: STROMANSCHLUSS**
- 3: LAUSPRECHERAUSGANG**
- 4: EIN-/AUSSCHALTER**

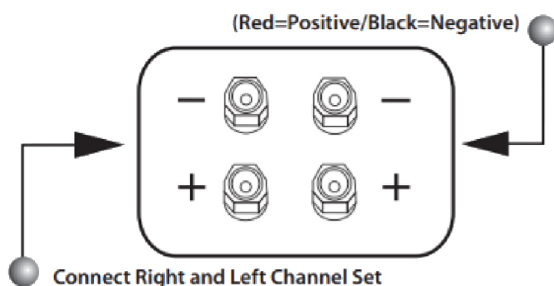

So verbinden Sie das Lautsprecherkabel mit dem Lautsprecher:

Klemme abschrauben.
Führen Sie den entsprechenden Draht unten ein.
Zur Sicherung festziehen.

VERDRAHTUNG

Beim Anschließen der Lautsprecher ist es sehr wichtig, sich mit der richtigen Polarität zu verbinden. Dies bedeutet, dass der Draht, der an der Rot / Positiv (+) Klemme an einer Komponente befestigt ist, an der Rot / Positiv (+) Klemme an der entsprechenden Komponentenlautsprecherklemme befestigt werden muss. Ebenso müssen die Schwarz / Negativ / Masse (-) Klemmen mit den jeweiligen Schwarz / Negativ / Masse (-) Klemmen verbunden werden. Dies ist einfach, indem Sie die (+) & (-) Etiketten finden, die auf dem mitgelieferten Lautsprecherkabel erscheinen. Wenn ein längerer Drahtlauf erforderlich ist, verwenden Sie wetterfesten 16-Gauge-Draht bis zu 50 Fuß.

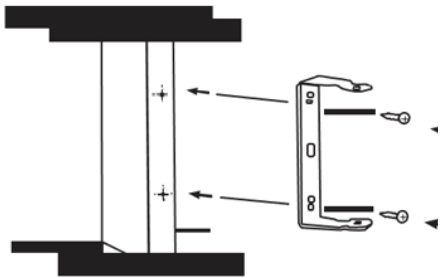

Platzieren von Lautsprechern

Wenn Ihre Anwendung erfordert, dass der Lautsprecher montiert wird, befolgen Sie bitte diese Anweisungen. Montieren Sie die Halterung mit den entsprechenden Schrauben (nicht im Lieferumfang enthalten). Befestigen Sie die Lautsprecher mit den mitgelieferten großen Kunststoffknöpfen an den Halterungen.

Montage

So installieren Sie die Halterung am Lautsprecher. Schrauben Sie die Halterungsknöpfe in den Schrank. Richten Sie den Lautsprecher auf den Hörbereich aus. Sobald die Richtung des Lautsprechers festgelegt wurde, ziehen Sie die Halterungsknöpfe sicher fest. Wenn möglich, neigen Sie die Lautsprecher nach unten, um die Langlebigkeit zu erhöhen und Wetterelemente zu vermeiden.

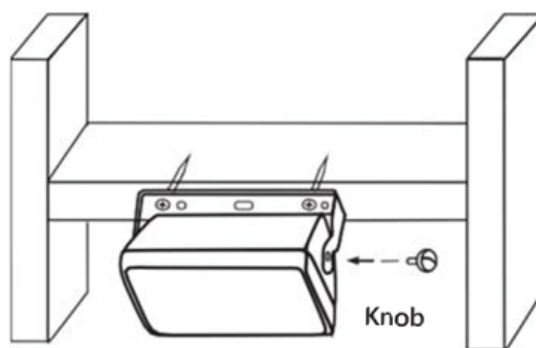

Method of Use

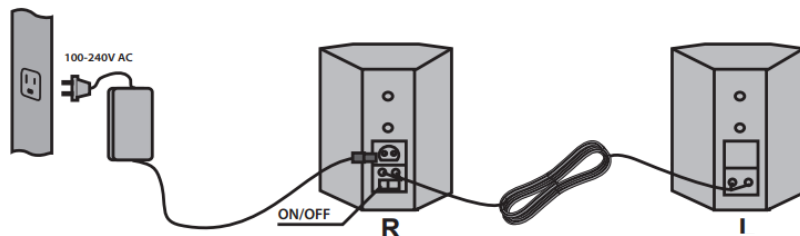

Ersteinrichtung

- Bluetooth-Gerät einschalten
- Öffnen Sie die Bluetooth-Einstellungen
- Wählen Sie die entsprechende Bluetooth-ID für die Verbindung aus (Sie hören die Bestätigung der Voice-Eingabeaufforderung)
- Sie können jetzt Audio von Ihrem gekoppelten Gerät abspielen
- Steuern Sie die Lautstärke über Bluetooth-Gerät oder Fernbedienung

Für nachfolgende Kopplungen stellt Bluetooth automatisch eine Verbindung her, wenn sich Ihr Gerät in der Nähe befindet und Bluetooth aktiviert ist. Um ein anderes Gerät zu verbinden, deaktivieren Sie Bluetooth auf Ihrem Originalgerät.



BLUETOOTH PAIRING NAMES

- iHome iHSI-400BT
- iHome iHSI-525BT
- iHome iHSI-650BT

RESERVE

Nach 10 Minuten ohne Audiosignal wechselt der Lautsprecher automatisch in den Standby-Modus. Drücken Sie den Netzschalter der Fernbedienung, um ihn wieder einzuschalten. Der Lautsprecher verbindet sich automatisch wieder mit dem letzten Gerät im Speicher.



ABGELEGEN

SPRACHAUFFORDERUNGEN ZU WÖRTERN:

- Einschalten
- Verbunden
- Entfernt

LEISTUNGSBESCHREIBUNG

LEISTUNGSBESCHREIBUNG	Wetterfester Lautsprecher für den Innen- und Außenbereich
<i>TEILENUMMER:</i>	IHSI-W400BT-PR-BLK / IHSI-W400BT-PR-WHT
<i>BLUETOOTH:</i>	Bluetooth Spezifikation 4.1+A2DP
<i>AUDIO-EINGÄNGE:</i>	Bluetooth-kompatible Geräte
<i>AKUSTISCHE</i>	2 x 12W RMS / 24W Musikleistung
<i>AUDIO-LEISTUNG:</i>	AC100-240V
<i>WOOFER:</i>	4 "Spritzgegossene PP-Kegel-Butyl-Gummi-Surround
<i>HOCHTÖNER:</i>	1" PET-Dome
<i>PACKUNGSABMESS</i>	36.7X25.8X22.2cm (Paar)
<i>PACKGEWICHT:</i>	4,6 kg (Paar)
<i>FARBE:</i>	Schwarz/Weiß

LEISTUNGSBESCHREIBUNG	Wetterfester Lautsprecher für den Innen- und Außenbereich
<i>TEILENUMMER:</i>	IHSI-W525BT-PR-BLK / IHSI-W525BT-PR-WHT
<i>BLUETOOTH:</i>	Bluetooth Spezifikation 4.1+A2DP
<i>AUDIO-EINGÄNGE:</i>	Bluetooth-kompatible Geräte
<i>AKUSTISCHE</i>	2 x 15W RMS / 30W Musikleistung
<i>AUDIO-LEISTUNG:</i>	AC100-240V
<i>WOOFER:</i>	5,25 "spritzgegossene PP-Kegel-Butyl-Gummi-Surround
<i>HOCHTÖNER:</i>	0,75-Zoll-PET-Dome
<i>PACKUNGSABMESS</i>	40.5X28X23.5cm (Paar)
<i>PACKGEWICHT:</i>	5,26 kg (Paar)
<i>FARBE:</i>	Schwarz/Weiß

LEISTUNGSBESCHREIBUNG	Wetterfester Lautsprecher für den Innen- und Außenbereich
<i>TEILENUMMER:</i>	IHSI-W650BT-PR-BLK / IHSI-W650BT-PR-WHT
<i>BLUETOOTH:</i>	Bluetooth Spezifikation 4.1+A2DP
<i>AUDIO-EINGÄNGE:</i>	Bluetooth-kompatible Geräte
<i>AKUSTISCHE</i>	2 x 20W RMS / 40W Musikleistung
<i>AUDIO-LEISTUNG:</i>	AC100-240V
<i>WOOFER:</i>	6,50 "spritzgegossene PP-Kegel-Butyl-Gummi-Surround
<i>HOCHTÖNER:</i>	1" PET-Dome
<i>PACKUNGSABMESS</i>	46X33X25cm (Paar)
<i>PACKGEWICHT:</i>	7,0 kg (Paar)
<i>FARBE:</i>	Weiß/Schwarz

TRATTI SOMATICI

La soluzione definitiva per le tue esigenze audio Bluetooth® all'aperto. Questi altoparlanti montabili sono ideali per cortili e patii, sia per uso domestico che aziendale. Puoi persino installare questi altoparlanti su una barca! Con un grado di impermeabilità ip44, non dovrai preoccuparti di lasciare i tuoi altoparlanti installati all'esterno negli elementi, sono al sicuro da acqua e polvere. Le staffe di montaggio regolabili facilitano l'installazione e consentono una dispersione sonora ottimale. Gli altoparlanti per esterni della serie iHSI si accoppiano facilmente al dispositivo Bluetooth e il telecomando wireless mette il controllo nelle tue mani. Questi altoparlanti sono specificamente sintonizzati per l'uso all'aperto, con conseguente suono enorme da un pacchetto compatto in modo da poter riempire le tue feste in piscina, barbecue o qualsiasi altro evento all'aperto con un suono senza rivali, sicuro di impressionare i tuoi ospiti

ALTOPARLANTE ESTERNO PER TUTTE LE STAGIONI

Con un grado di protezione IP44, la serie iHSI è resistente all'acqua e alla polvere, appositamente progettata per resistere alla maggior parte degli ambienti.

COPPIA ALTOPARLANTI ATTIVI/PASSIVI

Include un altoparlante attivo e un altoparlante passivo, collegare con il cavo dell'altoparlante incluso. Solo l'altoparlante attivo dovrà essere collegato all'alimentazione.

BLUETOOTH®

Connessione wireless super semplice. Una volta collegato il dispositivo preferito tramite Bluetooth®, si conatterà automaticamente in futuro. L'indicatore LED visualizza lo stato della connessione.

TELECOMANDO

Il telecomando wireless incluso mette il controllo nelle tue mani. Il telecomando consente di accendere / spegnere, accoppiare, silenziare e regolare i controlli volume, EQ e riproduzione.

GRANDE SUONO, PACCHETTO COMPATTO

Amplificatore di classe D specificamente sintonizzato per uso esterno e progettazione di utensili per armadi personalizzati.

INSTALLAZIONE ALTOPARLANTI

Questi altoparlanti resistenti alle intemperie per interni / esterni sono fabbricati per resistere a una varietà di condizioni meteorologiche tra cui neve, pioggia e sole (ma non per essere sommersi sott'acqua). Per durata / longevità, si consiglia di rimuovere gli altoparlanti dalle staffe e di riporli all'interno durante temperature estreme estese superiori a 120 ° F e inferiori a 0 ° F. Il luogo più ideale per installare questi altoparlanti è sotto sporgenze, in quanto forniscono la migliore protezione. Come tutti gli altoparlanti, suonano al meglio se posizionati a non più di otto piedi di distanza l'uno dall'altro e leggermente più in alto del livello dell'orecchio. Quando si sceglie il posizionamento dell'altoparlante, considerare la posizione della fonte di alimentazione. L'altoparlante alimentato deve essere posizionato vicino alla fonte di alimentazione. L'altoparlante passivo può essere posizionato più lontano e deve essere collegato all'altoparlante alimentato con il cavo incluso.

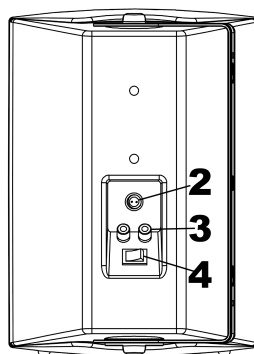
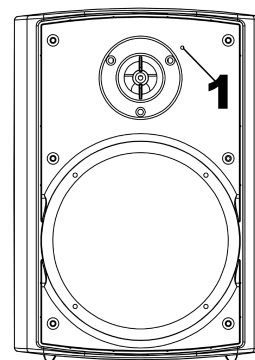

- 1: INDICATORE LED**
- 2: PORTA DI ALIMENTAZIONE**
- 3: USCITA ALTOPARLANTE**
- 4: INTERRUTTORE ON / OFF**

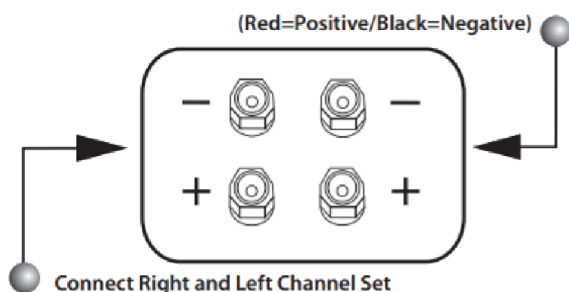

Per collegare il cavo dell'altoparlante all'altoparlante:

- Svitare il terminale.
- Inserire il cavo appropriato sotto.
- Stringere per fissare.

CABLAGGIO

Quando si collegano gli altoparlanti, è molto importante connettersi con la polarità corretta. Ciò significa che il filo collegato al terminale rosso / positivo (+) su un componente deve essere collegato al terminale rosso / positivo (+) sul terminale dell'altoparlante componente corrispondente. Allo stesso modo, i terminali Nero / Negativo / Terra (-) devono connettersi ai rispettivi terminali Nero / Negativo / Terra (-). Questo è facile da fare individuando le etichette (+) e (-) che appaiono sul cavo dell'altoparlante incluso. Se è necessaria una corsa del filo più lunga, utilizzare un filo resistente alle intemperie calibro 16 fino a 50 piedi.

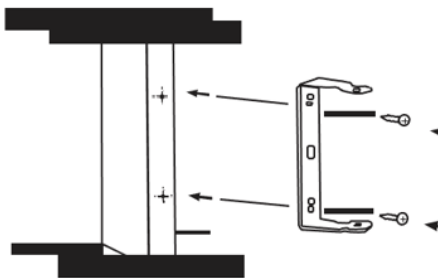

Posizionamento degli altoparlanti

Se la tua applicazione richiede il montaggio dell'altoparlante, segui queste istruzioni. Utilizzando le apposite viti (non incluse) montare la staffa. Collegare gli altoparlanti alle staffe utilizzando le grandi manopole di plastica in dotazione.

Cantone di Montante

Per installare la staffa sull'altoparlante. Avvitare le manopole della staffa nell'armadio. Puntare l'altoparlante verso l'area di ascolto. Una volta determinata la direzione dell'altoparlante, stringere saldamente le manopole della staffa. Quando possibile, inclinare gli altoparlanti verso il basso per aumentare la longevità e prevenire gli elementi atmosferici.

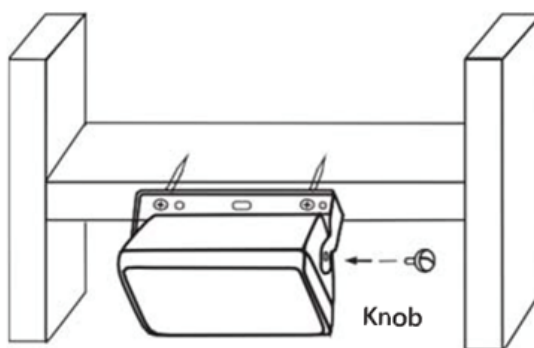

Method of Use

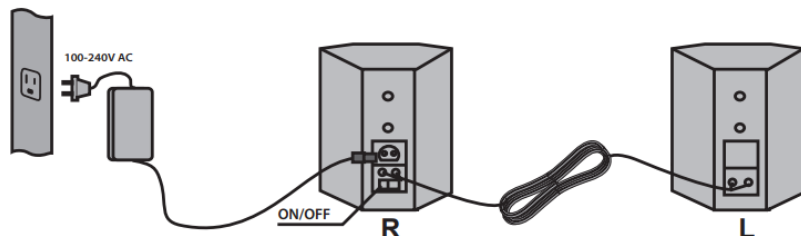

Bluetooth™



BLUETOOTH PAIRING NAMES

- iHome iHSI-400BT
- iHome iHSI-525BT
- iHome iHSI-650BT

Configurazione iniziale

- Accendi il dispositivo Bluetooth
- Apri le impostazioni Bluetooth
- Seleziona l'ID Bluetooth appropriato per la connessione (sentirai la conferma di Voice Prompt)
- Ora puoi riprodurre Audio dal dispositivo associato
- Controllo del volume tramite dispositivo Bluetooth o telecomando

Per gli abbinamenti successivi, il Bluetooth si conetterà automaticamente quando il dispositivo si trova nelle vicinanze con il Bluetooth attivato. Per connettere un altro dispositivo, disattiva il Bluetooth sul dispositivo originale.

STANDBY

Dopo 10 minuti senza segnale audio, l'altoparlante entrerà automaticamente in modalità standby. Ripeti il pulsante di accensione del telecomando per riaccenderlo. L'altoparlante si riconnetterà automaticamente all'ultimo dispositivo in memoria.

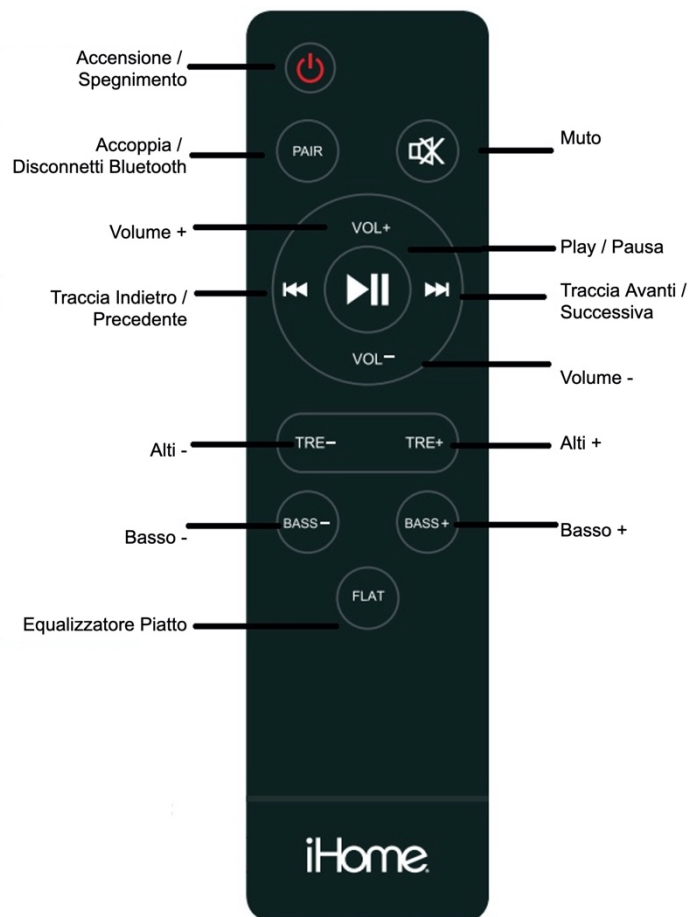

REMOTO

LA VOCE RICHIEDE PAROLE:

- Accensione
- Connesso
- Sconnesso

INDICAZIONI

INDICAZIONI	Altoparlante resistente alle intemperie per interni / esterni
<i>CODICE ARTICOLO:</i>	IHSI-W400BT-PR-BLK / IHSI-W400BT-PR-WHT
<i>BLUETOOTH:</i>	Specifica Bluetooth 4.1 + A2DP
<i>INGRESSI AUDIO:</i>	Dispositivi compatibili con Bluetooth
<i>USCITA ACUSTICA:</i>	2 x 12W RMS / 24W Potenza musicale
<i>POTENZA AUDIO:</i>	AC100-240V
<i>WOOFER:</i>	4 "Cono pp stampato a iniezione cono butilico surround in
<i>TWEETER:</i>	Cupola in PET da 1"
<i>DIMENSIONI</i>	36.7X25.8X22.2cm (coppia)
<i>PESO DELLA</i>	4.6kgs (coppia)
<i>COLORE:</i>	Nero/Bianco

INDICAZIONI	Altoparlante resistente alle intemperie per interni / esterni
<i>CODICE ARTICOLO:</i>	IHSI-W525BT-PR-BLK / IHSI-W525BT-PR-WHT
<i>BLUETOOTH:</i>	Specifica Bluetooth 4.1 + A2DP
<i>INGRESSI AUDIO:</i>	Dispositivi compatibili con Bluetooth
<i>USCITA ACUSTICA:</i>	2 x 15W RMS / 30W Potenza musicale
<i>POTENZA AUDIO:</i>	AC100-240V
<i>WOOFER:</i>	5.25 "Cono PP stampato a iniezione Cono Butilico
<i>TWEETER:</i>	Cupola in PET da 0,75"
<i>DIMENSIONI</i>	40.5X28X23.5cm (coppia)
<i>PESO DELLA</i>	5.26kgs (coppia)
<i>COLORE:</i>	Nero/Bianco

INDICAZIONI	Altoparlante resistente alle intemperie per interni / esterni
<i>CODICE ARTICOLO:</i>	IHSI-W650BT-PR-BLK / IHSI-W650BT-PR-WHT
<i>BLUETOOTH:</i>	Specifica Bluetooth 4.1 + A2DP
<i>INGRESSI AUDIO:</i>	Dispositivi compatibili con Bluetooth
<i>POTENZA DI USCITA</i>	2 x 20W RMS / 40W Potenza musicale
<i>POTENZA AUDIO:</i>	AC100-240V
<i>WOOFER:</i>	6.50 "Pressed PP Cono Butile Surround in gomma butilica
<i>TWEETER:</i>	Cupola in PET da 1"
<i>DIMENSIONI</i>	46X33X25cm (coppia)
<i>PESO DELLA</i>	7.0kgs (coppia)
<i>COLORE:</i>	Bianco/Nero

FUNCTIES

De ultieme oplossing voor uw Outdoor Bluetooth audio® behoeften. Deze montageerbare luidsprekers zijn ideaal voor achtertuinen en patio's, of het nu voor thuis- of zakelijk gebruik is. Je kunt deze speakers zelfs op een boot installeren! Met een waterdichtheid van IP44 hoeft u zich geen zorgen te maken dat uw luidsprekers buiten in de elementen zijn geïnstalleerd, ze zijn veilig voor water en stof. Verstelbare montagebeugels zorgen voor een eenvoudige installatie en zorgen voor een optimale geluidsverdeling. De iHSI-serie buitenluidsprekers kunnen eenvoudig worden gekoppeld aan uw Bluetooth-apparaat en de draadloze afstandsbediening legt de bediening in uw handen. Deze luidsprekers zijn speciaal afgestemd op gebruik buitenshuis, wat resulteert in een enorm geluid uit een compact pakket, zodat u uw zwembadfeesten, barbecues of een ander buitenevenement kunt vullen met ongeëvenaard geluid, zodat u zeker indruk zult maken op uw gasten

ALL WEATHER OUTDOOR SPEAKER

Met een IP44-classificatie is de iHSI-serie water- en stofbestendig, speciaal ontworpen om de meeste omgevingen te weerstaan.

ACTIEF/PASSIEF LUIDSPREKERPAAR

Inclusief een actieve luidspreker en een passieve luidspreker, aansluiten met de meegeleverde luidsprekerdraad. Alleen de actieve luidspreker hoeft op voeding te worden aangesloten.

Bluetooth-netwerk®

Supereenvoudige draadloze verbinding. Zodra u uw favoriete apparaat via Bluetooth® verbindt, maakt het in de toekomst automatisch verbinding. LED-indicator geeft de verbindingstatus weer.

AFSTANDSBEDIENING

De meegeleverde draadloze afstandsbediening legt de bediening in uw handen. Met remote kunt u de bedieningselementen Volume, EQ en Playback in- en uitschakelen, koppelen, dempen en aanpassen.

GROOTS GELUID, COMPACT PAKKET

D-klasse versterker speciaal afgestemd voor gebruik buitenshuis en aangepast kast gereedschapsontwerp.

LUIDSPREKER INSTALLATIE

Deze weerbestendige luidsprekers voor binnen en buiten zijn vervaardigd om bestand te zijn tegen een verscheidenheid aan weersomstandigheden, waaronder sneeuw, regen en zon (maar niet om onder water te worden ondergedompeld.) Voor duurzaamheid / levensduur raden we aan om de luidsprekers van de beugels te verwijderen en binnenshuis op te bergen tijdens langdurige extreme temperaturen van meer dan 120 ° F en minder dan 0 ° F. De meest ideale plaats om deze luidsprekers te installeren is onder overhangen, omdat ze de beste bescherming bieden. Zoals alle luidsprekers klinken ze het beste wanneer ze niet meer dan acht voet van elkaar verwijderd zijn en iets hoger dan oorhoogte. Houd bij het kiezen van de luidsprekerplaatsing rekening met de locatie van de voedingsbron. De actieve luidspreker moet in de buurt van de voedingsbron worden geplaatst. De passieve luidspreker kan verder weg worden geplaatst en moet met de meegeleverde draad op de actieve luidspreker worden aangesloten.

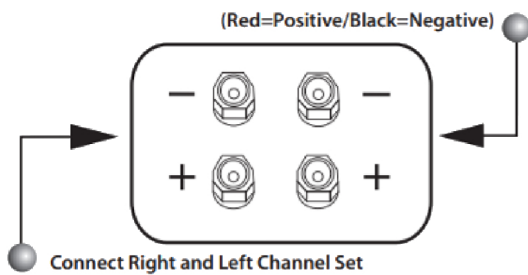

Luidsprekerkabel op luidspreker aansluiten:

Schroef de klem los.
Plaats de juiste draad hieronder.
Draai vast om vast te zetten.

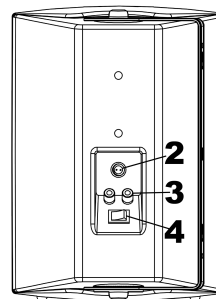
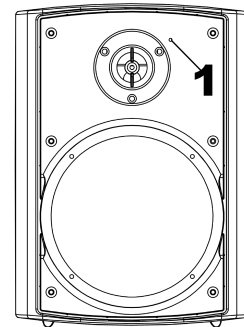

- 1: LED-INDICATOR**
- 2: VOEDINGSPOORT**
- 3: LUIDSPREKER UITGANG**
- 4: AAN/UIT SCHAKELAAR**

BEDRADING

Bij het aansluiten van de luidsprekers is het erg belangrijk om verbinding te maken met de juiste polariteit. Dit betekent dat de draad die is bevestigd aan de rode / positieve (+) terminal op één component moet worden bevestigd aan de rode / positieve (+) terminal op de overeenkomstige

componentluidsprekeraansluiting. Evenzo moeten de Black / Negative / Ground (-) terminals verbinding maken met de respectievelijke Black / Negative / Ground (-) terminals. Dit is eenvoudig te doen door de (+) & (-) labels te lokaliseren die op de meegeleverde luidsprekerdraad verschijnen. Als een langere draadloop nodig is, gebruik dan 16-gauge weerbestendige draad tot 50 voet.

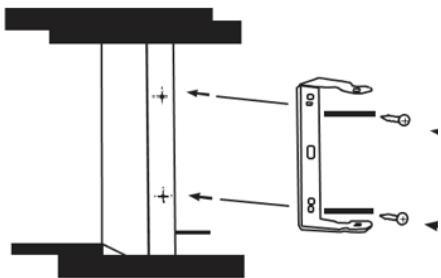

Luidsprekers plaatsen

Als uw toepassing vereist dat de luidspreker wordt gemonteerd, volgt u deze aanwijzingen. Gebruik de juiste schroeven (niet inbegrepen) om de beugel te monteren. Bevestig de luidsprekers aan de beugels met behulp van de grote meegeleverde plastic knoppen.

Montage

Om de beugel op de luidspreker te installeren. Schroef de beugelknoppen in de kast. Richt de luidspreker in de richting van het luistergebied. Zodra de richting van de luidspreker is bepaald, draai je de beugelknoppen stevig vast. Kantel de luidsprekers indien mogelijk naar beneden om de levensduur te verlengen en de weerselementen te voorkomen.

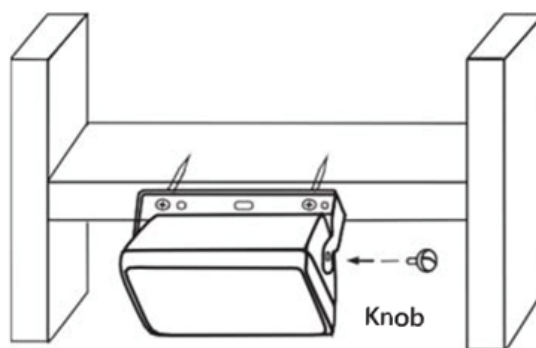

Method of Use

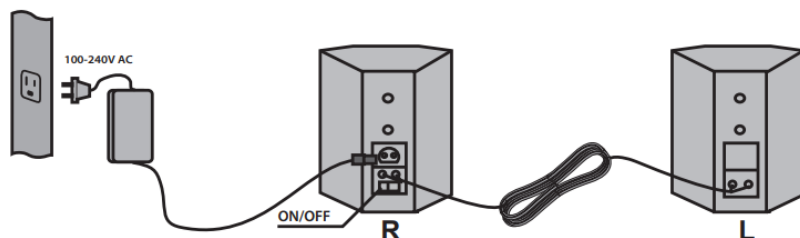

Bluetooth™



BLUETOOTH PAIRING NAMES

- iHome iHSI-400BT
- iHome iHSI-525BT
- iHome iHSI-650BT

Initiële installatie

- Bluetooth-apparaat inschakelen
- Open de Bluetooth-instellingen
- Selecteer de juiste Bluetooth-ID voor verbinding (u hoort Voice Prompt bevestiging)
- U kunt nu audio afspelen vanaf uw gekoppelde apparaat
- Volume regelen via Bluetooth-apparaat van afstandsbediening

Voor volgende koppelingen maakt Bluetooth automatisch verbinding wanneer uw apparaat in de buurt is en Bluetooth is ingeschakeld. Als u een ander apparaat wilt verbinden, schakelt u Bluetooth UIT op uw oorspronkelijke apparaat.

STANDBY

Na 10 minuten zonder audiosignaal gaat de luidspreker automatisch naar de stand-bymodus.

Open de aan /uit-knop van de afstandsbediening om weer in te schakelen. De luidspreker maakt automatisch opnieuw verbinding met het laatste apparaat in het geheugen.

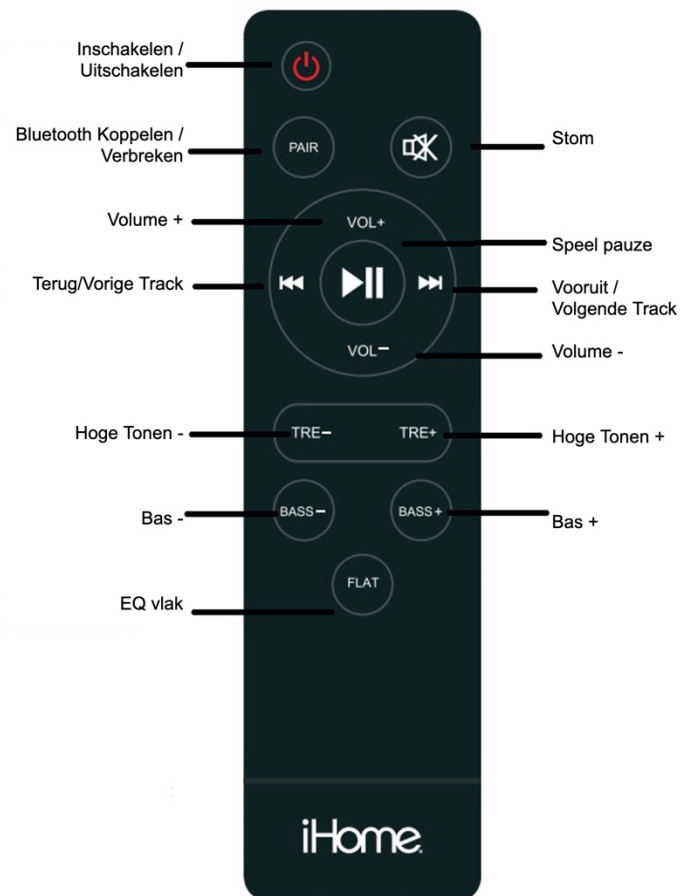

AFGELEGEN

STEM VRAAGT WOORDEN:

- Inschakelen
- Verbonden
- Verbroken

SPECIFICATIES

SPECIFICATIES	Weerbestendige luidspreker voor binnen en buiten
<i>PARTNUMMER:</i>	IHSI-W400BT-PR-BLK / IHSI-W400BT-PR-WHT
<i>BLUETOOTH:</i>	Bluetooth-specificatie 4.1 + A2DP
<i>AUDIO-INGANGEN:</i>	Bluetooth-compatibele apparaten
<i>AKOESTISCHE</i>	2 x 12W RMS / 24W muziekvermogen
<i>AUDIO VERMOGEN:</i>	AC100-240V
<i>WOOFER:</i>	4 "Spuitgegoten PP Cone Butyl Rubber Surround
<i>TWEETER:</i>	1" PET Koepel
<i>AFMETINGEN</i>	36.7X25.8X22.2cm (paar)
<i>GEWICHT VAN DE</i>	4,6 kg (paar)
<i>KLEUR:</i>	Zwart/Wit

SPECIFICATIES	Weerbestendige luidspreker voor binnen en buiten
<i>PARTNUMMER:</i>	IHSI-W525BT-PR-BLK / IHSI-W525BT-PR-WHT
<i>BLUETOOTH:</i>	Bluetooth-specificatie 4.1 + A2DP
<i>AUDIO-INGANGEN:</i>	Bluetooth-compatibele apparaten
<i>AKOESTISCHE</i>	2 x 15W RMS / 30W muziekvermogen
<i>AUDIO VERMOGEN:</i>	AC100-240V
<i>WOOFER:</i>	5.25 "Spuitgegoten PP Cone Butyl Rubber Surround
<i>TWEETER:</i>	0,75" PET Dome
<i>AFMETINGEN</i>	40.5X28X23.5cm (paar)
<i>GEWICHT VAN DE</i>	5.26kgs (paar)
<i>KLEUR:</i>	Zwart/Wit

SPECIFICATIES	Weerbestendige luidspreker voor binnen en buiten
<i>PARTNUMMER:</i>	IHSI-W650BT-PR-BLK / IHSI-W650BT-PR-WHT
<i>BLUETOOTH:</i>	Bluetooth-specificatie 4.1 + A2DP
<i>AUDIO-INGANGEN:</i>	Bluetooth-compatibele apparaten
<i>AKOESTISCH</i>	2 x 20W RMS / 40W muziekvermogen
<i>AUDIO VERMOGEN:</i>	AC100-240V
<i>WOOFER:</i>	6.50 "Spuitgegoten PP Cone Butyl Rubber Surround
<i>TWEETER:</i>	1" PET Koepel
<i>AFMETINGEN</i>	46X33X25cm (paar)
<i>GEWICHT VAN DE</i>	7.0kgs (paar)